

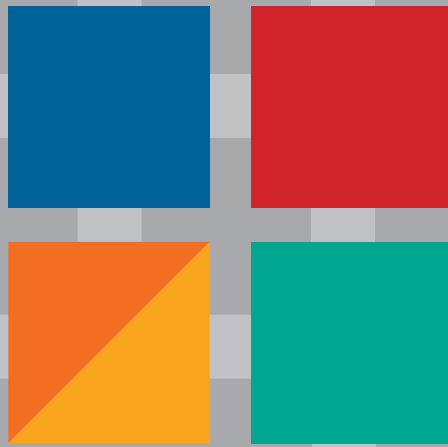

improve your life



AIR CONDITIONERS
PROFESSIONAL CATALOGUE

2011



improve your life

THE COMPANY, THE PRODUCTS & THE RELEVANT MARKET

Argoclima S.p.A., a company belonging to AER.FI. group, is specialized in providing products and services in the market of air conditioning, heating and air treatment.

The range of products, largely designed and built in two factories of the group, consists of advanced solutions for technology level, design and modularity, all of which help to brilliantly solve various kinds of problems and offer effective solutions with top level of energy efficiency.

In addition to products commonly offered through retail channel (portable air conditioners, wall systems, dehumidifiers, complementary heating ...), our company offers with its own brand Argo, direct expansion air conditioning systems from 2.2 to 150 kW thermal power with COP levels above 5.

Segmentation by thermal power allows to immediately identify the offer location and positioning, focused and specialized in applications that extend from the house to the building for offices, from small and medium size to big shopping centers ... Direct expansion systems are basically sharing the use of Full DC inverter technology up to 14 kW; for higher power levels is used the technology of variable volume refrigerant (VRF) which, together with the Full DC inverter control, allows the realization of systems with many tens of indoor units, with over 300 meters of pipes and slopes between units over 50 meters.

Condensing units and terminal units are designed with the most modern techniques of design and production, work brilliantly with a range of outdoor temperatures from -20°C to +43 ° C, have mechanical properties that facilitate handling and installation, reducing therefore the realization cost of the systems and are manageable with modern techniques of building automation (CIB / BMS), through local controllers, centralized and / or remote web interface and field-bus interfaces (lonworks. ...).



ORGANIZATION & SERVICES

Argoclima S.p.A. organization is structured and sized to better support the various types of clients; the needs of retail customers, compared to those of installers, wholesalers and professionals in the B2B channel, are sometimes similar and sometimes very different.

Also private consumer finds answers to his questions through resources and traditional services and using more & more new telematics technologies; www.argoclima.com website provides a wealth of information at various levels of expertise and access, to satisfy any request.

A network of Technical Assistance Centers and the European Spare Part Center ensure quality in after sales services; Technical Assistance Centers are connected via Internet to specific web applications with which they manage the various phases of scheduled or corrective maintenance.

To meet the particular needs of installers focused on the sale of centralized systems Argoclima S.p.A. provides appropriate services through the System Division organization:

- visits of inspection and requirements testing with the client and / or with the designer;
- proposal and / or choose of the best technology solution for the specific context /system installation design as a whole;
- support in the installation / start-up of the system;
- after-sales service with customized maintenance contracts;
- technical / commercial support over time for updating and adaptation to new technologies.

For the provision of services mentioned above, Argoclima S.p.A. employs technical and specialized commercial staff, updated on technological and regulatory issues.

Argoclima S.p.A. logistics hub is located near the city of Brescia and manages the entire process of logistics, both inbound and outbound, to clients throughout Europe and other nations of the world.

Argoclima S.p.A. is on the market since 80 years, an experience that is the evident assurance of the capacity of Innovation, Quality and Service of this company that still makes of "Made in Italy" its pride.

04

iSERIES 

Concepts, Connections, Indoor Units, Outdoor Units, Electronics, Technical Data

29

XFETTO 

Concepts, Applications, Technical Data Sheets

37

SPLIT/PACKAGE DCI

Technical Data Sheets, Accessories, Connections

61

SPLIT/PACKAGE ON OFF

Technical Data Sheets, Accessories, Connections

73

VRF SYSTEMS

Technical Data Sheets, Accessories, Connections

The concepts

The same outdoor unit can be either mono or multi.

The iSeries system provides a technological solution that has never been seen before. The same model of outdoor unit can be used in both mono-split and multi-split systems, in other words it can be connected to a single indoor unit or several indoor units up to its maximum cooling or heating capacity.

Each indoor unit is intelligent and able to configure itself to the size of the room it is installed in and the thermal load to be balanced.

The indoor units in the iSERIES range are equipped with an intelligent controller, which is able to consult a mathematical model built into the controller software based on a "small" or "large" room with respect to the real space in which the unit is fitted. Using this dynamic comparison, the machine provides the iSERIES outdoor unit with a constant flow of information via a communication bus. This information allows the outdoor unit to modulate the flow and volume of the refrigerant to adapt the yield of the indoor unit to the thermal load to be balanced. When the iFeel function is activated using the remote control, this refines operation even further and provides optimum and constant comfort.

7, 9, 12, 18, 24.. No more!

The special operating method used by the iSERIES system allows for a significant reduction in the number of indoor unit models by yield. We have no longer the traditional division into 7, 9, 12, 18, and 24000 BTU/h... We have just three different sizes, each of which can be switched between "small room / large room".

The three sizes are:

- **Size A** for a maximum thermal load up to 4 kW;
- **Size B** for a thermal load from 4 to 7 kW;
- **Size C** for a thermal load over 7 kW;

Intelligent electronics

The system electronics is based on the concept of an intelligent local network distributed over independent microprocessors located in each indoor/outdoor unit, similar to the client/server concept used in computer networks. The server is the outdoor unit, which manages the distribution of refrigerant to the indoor units dynamically without predetermining the volumes. Based on the thermal load detected by the microprocessor in each indoor unit, the system management microprocessor installed in the outdoor unit controls the motor management microprocessor and manages the expansion valves to modulate the volume of refrigerant to the indoor units.

The flow of refrigerant is controlled by modulating the compressor, whilst the electronic expansion valve controls the volume of refrigerant. Each indoor unit has a corresponding electronic expansion valve that modulates the volume of refrigerant based on the thermal load to be balanced.

This system architecture allows for the intelligent distribution of energy without predetermining the power of each single indoor unit, with a significant reduction in parts (indoor units) and thereby a significant simplification of the supply chain.

Advantages

Range simplification

Wide selection of applications

Integrated solutions

System scalability

Configurability based on requirements

System expandability

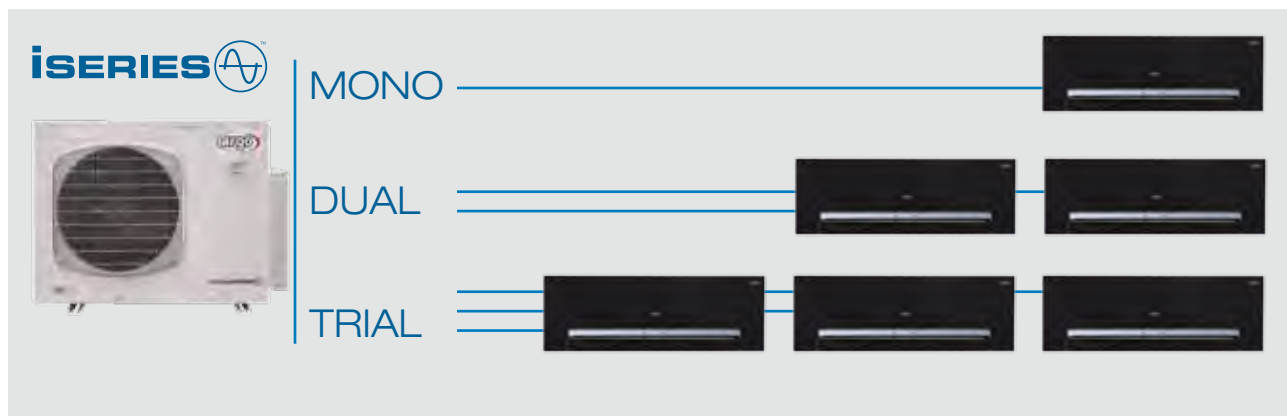

Special features of the iSERIES™ system

FULL DC inverter technology with SVPWM 180° modulation

The flow of refrigerant and the modulation of the compressor and fan motors are controlled by a sophisticated electronics 180° sinusoidal inverter installed in the outdoor units, which is able to control with maximum efficiency the torque of compressors through 360° of the rotation of the motor shaft (Space Vector PWM 180° modulation) without pauses during the injection of current into the windings of the permanent-magnet synchronous motors.

Extremely High Energy Efficiency, beyond AA class

“Non stop operation” during defrost: iSERIES does not stop providing heat during defrosting because it does not invert the cycle to carry out this important operating stage. The hot refrigerant that comes out of the compressor delivery pipe is drawn off and used to prevent the formation of ice on the heat exchanger of the outdoor unit. The value of this property lies in the algorithms that regulate the management of this portion of gas, which is drawn off without disturbing the heating operation.

“Wide range operation”: iSERIES can work with a very wide range of outdoor temperatures, from -32°C to over +50°C.

“Oil Freeze prevention” : a dedicated electrical heater prevents the compressor oil from freezing. This function is managed by the microprocessor in the outdoor unit. It is also active in stand by, when the processor is in sleep mode and whenever the outside temperature falls below zero degrees.

“Bottom plate antifreeze protection”: this function prevents the formation of ice on the bottom plate of the outdoor unit when outside temperatures fall below zero. This function is also managed by the microprocessor. Our solution is not only provided as standard

with “full options”, but also creates no problems for the installer, who would otherwise need to operate inside the device. In addition, efficiency (COP) is not reduced due to increased power consumption, only when it is necessary to switch on the protective device.

“Antifreeze and Low ambient indoor”: the regulation of ambient temperature from +10 to +32°C is a standard function, just like any other setpoint value and is operational both in heating mode (antifreeze) and cooling mode (low ambient indoor).

“PV Power”: this function can be activated by the remote control and is used to enable a special electronic control on the outdoor unit that optimises the electrical load when the air conditioner is supplied by a photovoltaic system.

“Domotics”: this function is available on the PCB indoor unit that allows the unit to be switched on/off by an external system and allows alerts to be received in the event of malfunctions.

“SuperLow EMC/EMF noise”: this indicates the low level of electromagnetic noise emission of our inverter platform; the electromagnetic emissions of our control system are 10% lower than European legislative requirements.

“Cold-draft prevention”: this function prevents the infiltration of cold air from the evaporators when the system has not yet warmed up.

Flexible power supply system, to be realized by the indoor unit, the outdoor unit or independently.

Power consumption is just over **1 watt in stand-by mode**.

iSERIES 

a system, not simply a split...

Today and tomorrow applications

The iSERIES system is designed to offer complete solutions for heating with heat pumps and air conditioning (as well as dehumidification, ventilation and air purification), for very different types of environments, from studio flats to buildings with 8 rooms.

Actually iSERIES can become a multi-split system with a variable number of indoor units that can be combined in “ad hoc” configurations up to a maximum number of 8. In the event that more indoor units are required, the iSERIES system can be further extended using the concept of “scalability”, up to maximum of four outdoor units and thirty two indoor units, all of which can be controlled individually, as a cluster, or completely centrally.

In applications with more than four indoor units, the iSERIES system can be considered as an ideal solution for light commercial applications, offices, hotels and restaurants and many other uses other than typical residential installations. iSERIES offers several dedicated features for light commercial applications such as control via integrated web server combined with configuration, maintenance, accounting and electrical and thermal energy management software.

An electrical power supply system optimised for photovoltaic solar panels is currently available for the AEI1G40 (also available on request for other models), which uses the “PV Power” function: this can be activated using the remote control and is used to enable a special electronic control of the outdoor unit that enables the optimisation of the electrical load when the air conditioner is supplied by a photovoltaic system.

The outdoor unit models currently available are:

AEI1G40 for mono applications
AEI1G50 for mono and dual applications
AEI1G65 for mono, dual and trial applications

The future of iSeries is made of new configurations, new outdoor units, new indoor units and additional functions that will allow to compose integrated solutions for residential and commercial applications.

New outdoor units **AEI1G80**, **AEI2G110**, **AEI2G110 three-phase**, **AEI2G140** and **AEI2G140 three-phase** are on the way and will be accompanied by **Size C** indoor units.

The current indoor units will still be fully compatible with the future outdoor units. The new units will be able to manage up to 8 uses of different types and sizes via the use of “**intelligent multiboxes**” known as **AMB2** and **AMB3**. The first of these has one input and two outputs, the second has one input and three outputs. Models **AEI1G40**, **AEI1G50** and **AEI1G65** have an “**embedded**” multibox, i.e. built into the machine. These appear to the installer as conventional multi-split system with two or three pipe connections.



Three outdoor units



AEI 1G 40

MONO



AEI 1G 50

MONO

DUAL



AEI 1G 65

MONO

DUAL

TRIAL

Indoor

HIGH WALL

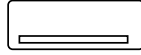

FLOOR/
CEILING

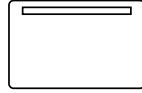

SLIM
DUCTED



CASSETTE

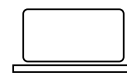

Size **a**  →

 AWIA^{S7F}

 FCIA^{S8}

 SDIA^{S8}

 ASIA^{S8}

 AWIA^{REF}

 AWIA^{S87}

 AWIA^{S8*}

Size **b**  →

 AWIB^{S9}

 FCIB^{S9}

 SDIB^{S9}

 ASIB^{S9**}

* High wall unit for applications with AE1G40

** In matching with AE1G65 only for multi applications, with AE1G50 only for mono applications.

Outdoor



AEI 1G 40



AEI 1G 50



AEI 1G 65

Matchings



a



b

a+a



b

a+a

b+a

b+b

a+a+a

a+a+b

Maximum pipe lengths and maximum distances between outdoor unit and indoor units

AEI 1G 40



AEI 1G 50



AEI 1G 65

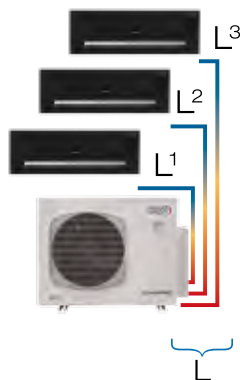

(L¹) Single lenght (L) Total lenght

The AEI1G50 outdoor unit equipped with a standard refrigerant charge (preloaded in factory), allows maximum pipe length of 7.5 metres in a mono configuration and up to 15 metres in dual configuration. By adding refrigerant (20 grams per metre in a mono configuration and 15 grams per metre in a dual configuration), the maximum length becomes 20 metres in mono configuration and 30 metres in dual configuration.

In the event of dual configurations it is also essential to consider that each of the two indoor units can be positioned at a different distance from the outdoor unit. As the maximum distance of the first indoor unit from the outdoor unit is 12 metres, the second indoor unit must be placed at a maximum distance of 3 metres from the outdoor unit. This is because the maximum total pipe length, which is 15 metres, must never be exceeded. Of course in the event of additional refrigerant, the maximum distance of the first indoor unit can be up to 25 metres and the second 5 metres.

Similar concepts can also be applied to outdoor unit AEI1G65, and the same shall apply for future outdoor units in the iSeries range.

The table below, combined with the schemes here on the left, allows you to easily identify the maximum values for the pipe lengths / maximum distances between outdoor and indoor units.

Outdoor unit	Configuration	Standard charge		Additional charge	
		Tot L	Max L	Tot L	Max L
AEI1G40	mono-split	15	-	15	-
AEI1G50	mono-split	7.5	-	20	-
AEI1G50	dual-split	15	12	30	25
AEI1G65	mono-split	20	-	35	-
AEI1G65	dual-split	30	25	45	30
AEI1G65	triple-split	30	20	45	25

Tot L = total pipes length, given by the sum of pipe lengths of each indoor unit
Max L = maximum pipe length per single indoor unit, whether it is no. 1, 2, 3...

Height differences between outdoor unit and indoor unit and between indoor units

The maximum height difference between the outdoor unit and indoor unit/s does not depend on the distances and/or the pipe lengths described above. It depends instead on the total height difference between the various units (outside and inside) that composing mono or multi-split system.

In multi-split configurations there is also a relationship between the maximum height difference between the outdoor unit and indoor units (sum of height differences) and the maximum height difference between two indoor units. For example, if the total maximum height difference between the outdoor unit and indoor units as declared by the manufacturer is 10 metres and the maximum height difference between the two indoor units is 5 metres, in a dual configuration with the outdoor unit on the ground floor, the first indoor unit can be installed at up to 7 metres above (or below), but the second unit may only be fitted a maximum of 3 metres above (or below). This is so as not to exceed 10 metres ($7+3 = 10$) and at the same time not to exceed the 5 metres of maximum height difference between the two indoor units ($7-3 = 4$).

On the other hand, it is not possible to position the first indoor unit at 8 metres and the other at 1 metre from the outdoor unit. This is because even though the sum of height differences is less than the maximum height difference of 10 metres ($8+1 = 9$), the height difference between the two indoor units would however reach 7 metres, exceeding the maximum permitted height difference.

Where the same dual configuration outdoor unit is positioned at a height in between the two indoor units, the first indoor unit can also be installed one metre below the outdoor unit. In this case the second indoor unit can be installed at a maximum of 4 metres above the outdoor unit because the maximum height difference of 5 metres between indoor units cannot be exceeded. With this type of installation the two indoor units are in fact usually placed at a height difference of 2.5 metres with respect to the outdoor unit.

Maximum height difference (sum of height differences)
AEI1G40 = 7 m
AEI1G50 = 10 m
AEI1G65 = 10 m

Maximum height difference between two indoor units (only for multi-split systems)
AEI1G50 = 5 m
AEI1G65 = 5 m

AEI 1G 40		Units	Cooling	Heating
Capacity Nominal (min.-max.)		kW	3,50 (1,25-4,25)	3,90 (1,20-5,20)
Energy label class		ABCDEFGF	A	A
E.E.R. / C.O.P. Nominal (min.-max.)		(kW/kW)	3,68 (4,63-3,00)	4,19 (6,32-3,30)
Minimum thermal load		W	1250	1200
Fan Speeds		n°	self modulating	
Sound Pressure (max.)		dB(A)	44	
Power Supply		V/Ph/Hz	230/1/50	
Power input Nominal (min.-max.)		kW	0,950 (0,27-1,415)	0,930 (0,19-1,575)
Annual energy consumption (500h)-Dir. 2002/31/EC		kWh	475	-
Compressor type			Rotary	
Refrigerant type			R410A	
Liquid pipe diameter		mm(inch")	6,35(1/4")	
Gas pipe diameter		mm(inch")	9,52(3/8")	
Pipe lenght		m	15	
Maximum height difference between units		m	7	
Net weight		Kg	39	
Net Dimensions (H./W./D.)		mm	630x895x345	

AEI 1G 50		Units	Cooling	Heating
Capacity Nominal (min.-max.)		kW	4,45 (2,55-5,25)	5,00 (2,65-5,35)
Energy label class		ABCDEFGF	A	A
E.E.R. / C.O.P. Nominal (min.-max.)		(kW/kW)	3,22 (4,11-2,64)	4,24 (5,02-3,89)
Minimum thermal load		W	2000	1950
Fan Speeds		n°	self modulating	
Sound Pressure (max.)		dB(A)	44	
Power Supply		V/Ph/Hz	230/1/50	
Power input Nominal (min.-max.)		kW	1,382 (0,620-1,989)	1,180 (0,520-1,375)
Annual energy consumption (500h)-Dir. 2002/31/EC		kWh	691	-
Compressor type			Rotary	
Refrigerant type			R410A	
Liquid pipe diameter		mm(inch")	6,35(1/4")	
Gas pipe diameter		mm(inch")	9,52(3/8")	
Total pipe lenght (with standard charge)		m	15 tot. Dual / 7,5 mono	
Total pipe lenght (with additional charge)		m	30 tot. Dual / 20 mono	
Pipe lenght - single unit (with standard charge)		m	12 Dual	
Pipe lenght - single unit (with additional charge)		m	25 Dual	
Maximum height difference between units		m	10 tot. Dual / 7 Mono	
Net weight		Kg	39	
Net Dimensions (H./W./D.)		mm	630x895x345	

AEI 1G 65		Units	Cooling	Heating
Capacity Nominal (min.-max.)		kW	6,50 (1,57-8,71)	7,30 (1,82-8,67)
Energy label class		ABCDEFGF	A	A
E.E.R. / C.O.P. Nominal (min.-max.)		(kW/kW)	3,25 (3,78-3,00)	4,32 (5,06-3,82)
Minimum thermal load		W	1200	800
Fan Speeds		n°	self modulating	
Sound Pressure (max.)		dB(A)	40	
Power Supply		V/Ph/Hz	230/1/50	
Power input Nominal (min.-max.)		kW	2,0 (0,415-2,90)	1,69 (0,36-2,27)
Annual energy consumption (500h)-Dir. 2002/31/EC		kWh	1000	-
Compressor type			Twin Rotary	
Refrigerant type			R410A	
Liquid pipe diameter		mm(inch")	6,35(1/4")	
Gas pipe diameter		mm(inch")	9,52(3/8") / 12,77(1/2")	
Total pipe lenght (with standard charge)		m	30 tot. Dual-Trial / 20 mono	
Total pipe lenght (with additional charge)		m	45 tot. Dual-Trial / 35 mono	
Pipe lenght - single unit (with standard charge)		m	12 Dual	
Pipe lenght - single unit (with additional charge)		m	25 Dual	
Maximum height difference between units		m	10 tot. Dual-Trial / 5 Mono	
Net weight		Kg	71	
Net Dimensions (H./W./D.)		mm	735x1030x400	

The technical data here indicated are in compliance with the European standard EN14511 - Directive 2002/31/EC



A8

Design, elegance & technology

Refined and elegant design, simple and linear, to be perfectly integrated in any style of furnishings, high quality sophisticated materials, discrete colours and attention to all details, aesthetics and functional: this is A8... white satin or glossy black carbon fiber panel, white and steely blu MicroLeds on a metallic support, to be disabled by remote control, make A8 technological, elegant and discreet.



High gloss ABS body and blue Leds, to be disabled by remote control

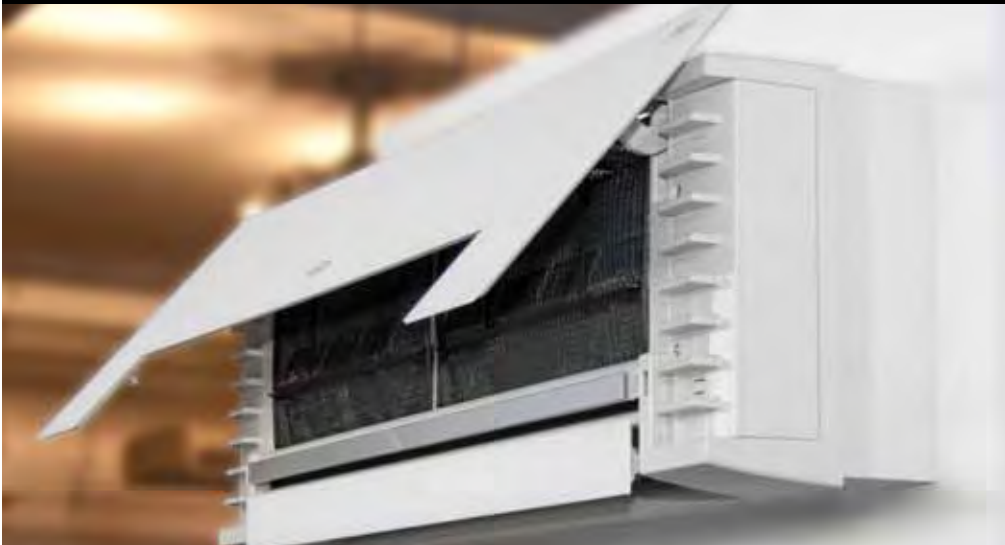

Fixing system with anchors and connection on right side also

RIGHT & LEFT
Condensate drain connection

Protective grid on flap, in compliance with EN60335 standard, allowing a safe installation even at height less than 2 meters from the floor



Black, carbon fiber



White, satiny

Special built-in kit



Dioxide of Titanium filter and air quality

This filter takes advantage of the oxidizing power of Titanium Dioxide (TiO2) to destroy bacteria and inhibit the activity of the virus. Also plays effective action in breaking the dust and dirt particles and preventing bad smells.

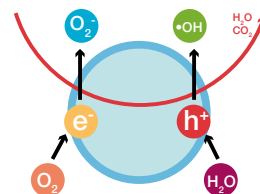

Organic compounds, smells, bacteria, viruses...

very quiet:
only 21 dB(A)

heat-exchanger
made of "inorganic hydrophilic aluminium"



REFLEXO

Not as usual

Different in the colour: aluminum is the colour of its structure, made of ABS coated with a special polyurethane paint.

Different in the finishes: the panel is covered with a special metallic laminate normally used for furniture finishes, with a reflecting and extremely elegant effect; white and steely blue microLeds, to be disabled by remote control, confer to the unit a technological and smooth aesthetic design.



RIGHT &
LEFT
Condensate
drain
connection

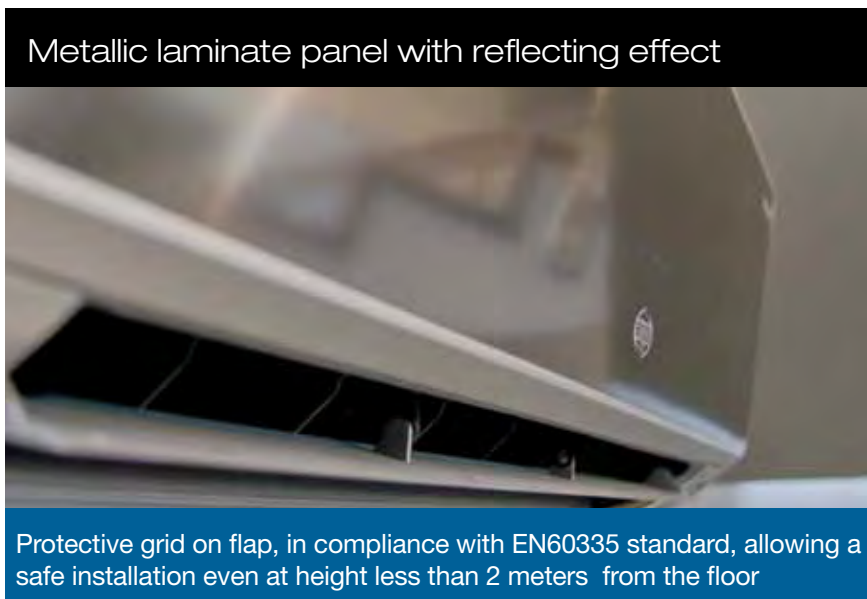

very quiet:
only 23 dB(A)

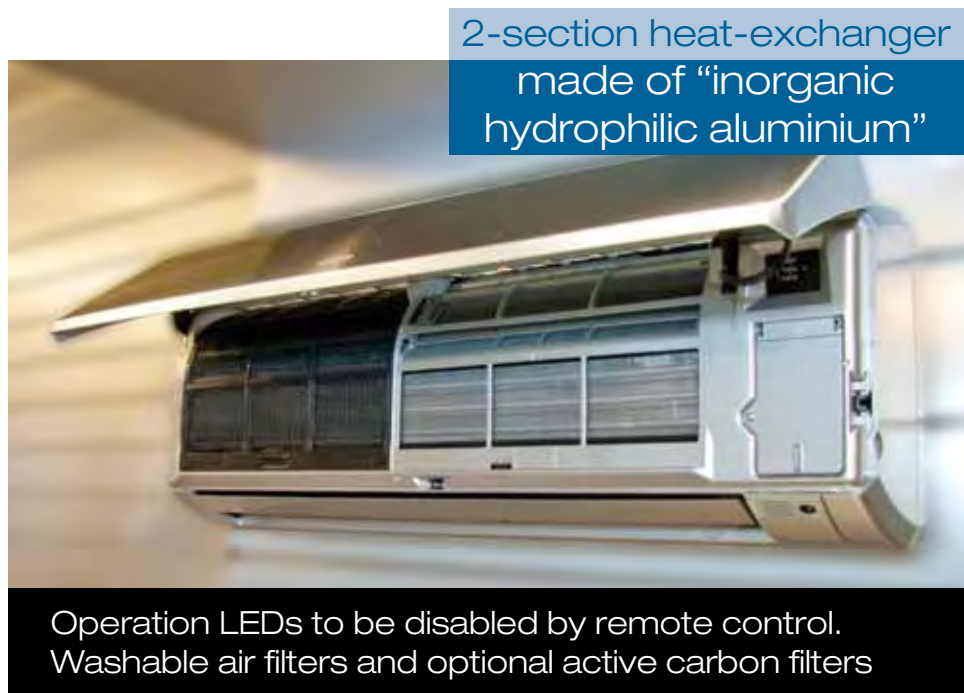



A7

Discrete and functional

A7 soft and sober aesthetic line enhances its elegance despite the simplicity of the forms. The whole body of the indoor unit is satin PS made, while the front panel is made of white satin plastics.

All materials are carefully selected and properly treated to endure unchanged over time.

A7 is so discreet to be comfortable anywhere ... and it's really easy to install and use.

A9

Double size indoor unit for a maximum installation flexibility



Protective grid on flap, in compliance with EN60335 standard, allowing a safe installation even at height less than 2 meters from the floor



RIGHT AND LEFT
Condensate drain connection

inorganic hydrophilic aluminium
heat-exchanger

very quiet:
only 23 dB(A)

Washable air filters with optional
anti smell active carbon action

The optional active carbon filter is composed of a layer of synthetic material folded to increase the filtering surface area and treated with a professional anti-bacterial solution, combined with an active carbon mesh.

Active carbon is a material mainly made up of carbon in the form of graphite micro crystals treated in such a way as to create a porous structure with a vast internal surface area.

When the forced air flow passes through the filter element, the charge of static energy allows the filter to trap even the smallest particles of pollutants and allergens, down to a size of 0.01 micron. The active carbon layer attracts and absorbs organic molecules responsible for unpleasant odours, thus eliminating unpleasant odours.



Indicator Leds
to be disabled by
remote control



For floor & ceiling installation

With its very small thickness (only 19 cm) and its simple but elegant design, FC is discreet and fits easily into any environment; it can be placed vertically on the floor at any point along the wall or in the space under the window, or horizontally on the ceiling. The structure is made of glossy PS and all materials are carefully selected and properly treated to endure unchanged over time.

Simplified installation and condensate draining



Easy Maintenance

very quiet:
only 24 dB(A)

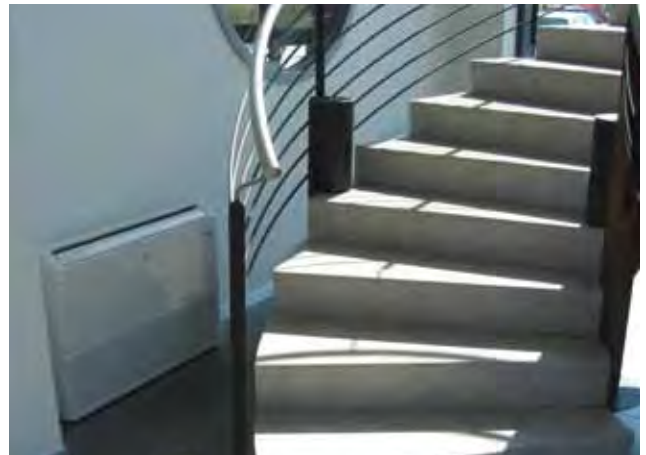

Always finds its place!



Ceiling installation

Indicator leds
to be disabled
by remote control

inorganic hydrophilic aluminium
heat-exchanger



Anti condensate dripping



To hide in the wall, in a closet or in the ceiling

Ultra-slim unit, ideal for those who want to hide the air conditioner in a false ceiling, even shallow, maybe on top of a door or installing it along a wall or on the floor, to clothe then it with a piece of furniture or a structure created for the purpose.

The body is made of painted metal, the heat exchanger of inorganic hydrophilic aluminium and the air filters can be completed with optional anti smell active carbon action.

Structure in painted and anti-corrosion metal



ONLY 19 CM!!!

Simplified installation and condensate draining



Vertical installation

inorganic hydrophilic aluminium
heat-exchanger

very quiet:
only 24 dB(A)



Orizzontal installation



Ideal in the false ceilings of shops, offices, bars...

4-way cassette with modern, compact and pleasant design, characterized by slightly rounded lines. Ideal for half-hidden installation in modular false ceiling 60 x 60 cm.

Ultra-slim grille (only 41 mm thick) made of white satin PS and internal structure in metal treated with anti-corrosive agents.

Multi-layer heat exchanger made of inorganic hydrophilic aluminium and washable air filters with easy inspection system for regular maintenance.



Half-hidden installation in modular false ceiling.
Easy installation and condensation discharge.



Perfect integration!

integrated condensate
drain pump

quiet:
only 35 dB(A)



Anti-condensation flocked flap

inorganic hydrophilic aluminium
heat-exchanger



Easy and practical maintenance

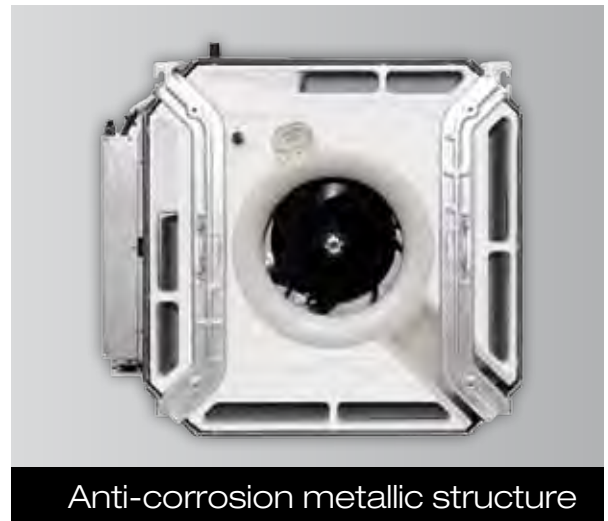

Anti-corrosion metallic structure



Universal Digital Remote Control

All parameters can be set by remote control: operating modes (auto or cooling only, heat pump only, dehumidification only, fan only) 1h and 24h timer, set point temperature, room temperature display, TiO2 filter activation (when fitted), fan speed selection, flap swinging for the best air distribution, "economy & night" selection... Several functions can be set automatically or managed at will, even the Led deactivation during the night.

Wide LCD display with graphic symbols and alphanumeric indicators



Wall support

“i Feel” function

A sensor installed in the remote control regularly transmits the room temperature to the electronic system of the indoor unit, which modulates the cold or hot airflow in order to reach and keep the desired temperature in the room. In this way the room temperature is regulated from the remote control position and not from the indoor unit place.



Temperature sensor inside

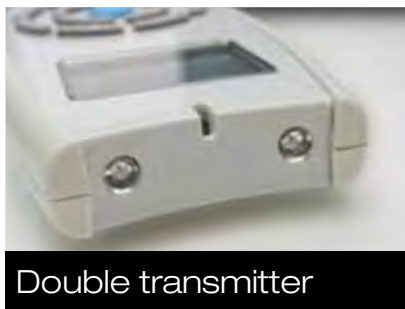

Double transmitter

Wide range

The double infrared transmitter inside the remote control grants a wide operating range: simply place the remote control where you want to be and you'll have the comfort You desire just in that particular place.

“i Flap” function

The airflow can be put in the room with “intelligence”, according to the operating mode, cooling or heating, thanks to the special control system of the horizontal flap swinging.

“Hi power” Funcion (turbo)

The maximum comfort now: when the air conditioner starts to operate, it develops a thermal power much higher than nominal in order to quickly reach the setpoint.



Adjustable set point from 10 to 32°C both in cooling and heating mode.

One for all

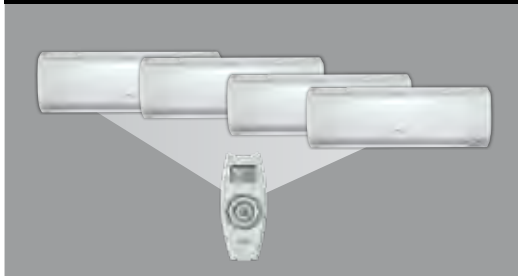

One to one

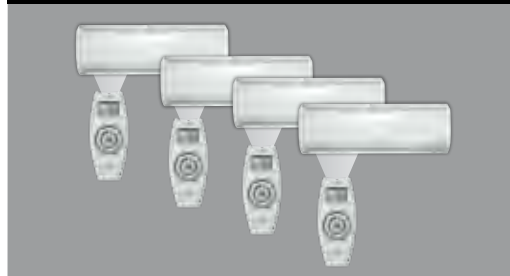

Multi-Addressing

The remote control can be addressed to four different units in “open space” in order to achieve a unified or custom control of temperature, timer, operation mode... etc.

Indoor Unit Technical Data

www.argoclima.com



iSeries



(B)



(W)

(A8)

	Units	AWIA S87 W/B	AWIA S8 W/B
Supported thermal load	kW	max 4 kW (iseries size A)	max 4 kW (iseries size A)
Air flowrate I.U. (l.-l.-m.-h.)	m ³ /h	250-410-480-600	250-410-480-600
Dehumidification	l/h	1,5	1,5
Fan speeds	n°	Auto + 3 by remote control	Auto + 3 by remote control
Sound pressure I.U. (l.-l.-m.-h.)	dB(A)	21-29-36-39	21-29-36-39
Sound power I.U. (l.-l.-m.-h.)	dB(A)	30-41-45-50	30-41-45-50
Power supply	V/Ph/Hz	230/1/50	230/1/50
Power input	kW	0,031	0,031
Running current	A	0,13	0,13
Liquid pipe diameter	mm (")	6,35(1/4")	6,35(1/4")
Gas pipe diameter	mm (")	9,52(3/8")	9,52(3/8")
Net Weight I.U.	Kg	10,5	10,5
Net dimensions (H.-W.-D./ Built in I.U. Depth)	mm	305x895x195/110	305x895x195/110



REF

	Units	AWIA REF
Supported thermal load	kW	max 4 kW (iseries size A)
Air flowrate I.U. (l.l.-l.-m.-h.)	m ³ /h	390-430-470-450
Dehumidification	l/h	1,5
Fan speeds	n°	Auto + 3 by remote control
Sound pressure I.U. (l.l.-l.-m.-h.)	dB(A)	23-29-36-39
Sound power I.U. (l.l.-l.-m.-h.)	dB(A)	32-38-45-48
Power supply	V/Ph/Hz	230/1/50
Power input	kW	0,031
Running current	A	0,13
Liquid pipe diameter	mm (")	6,35(1/4")
Gas pipe diameter	mm (")	9,52(3/8")
Net Weight I.U.	Kg	8
Net dimensions I.U. (H.-W.-D.)	mm	270x805x215



A7

A9

	Units	AWIA S7	AWIB S9
Supported thermal load	kW	max 4 kW (iseries size A)	4-7 kW (iseries size B)
Air flowrate I.U. (l.l.-l.-m.-h.)	m ³ /h	390-430-470-450	410-580-710-880
Dehumidification	l/h	1,5	2,0
Fan speeds	n°	Auto + 3 by remote control	Auto + 3 by remote control
Sound pressure I.U. (l.l.-l.-m.-h.)	dB(A)	23-29-36-39	29-35-43-47
Sound power I.U. (l.l.-l.-m.-h.)	dB(A)	32-38-45-48	38-44-52-56
Power supply	V/Ph/Hz	230/1/50	230/1/50
Power input	kW	0,031	0,031
Running current	A	0,13	0,13
Liquid pipe diameter	mm (")	6,35(1/4")	6,35(1/4")
Gas pipe diameter	mm (")	9,52(3/8")	12,7(1/2")
Net Weight I.U.	Kg	8	12
Net dimensions I.U. (H.-W.-D.)	mm	270x805x215	285x995x240

Indoor Unit Technical Data



Units		FCIA S8	FCIB S9
Supported thermal load	kW	max 4 kW (iseries size A)	4-7 kW (iseries size B)
Air flowrate (l.-l.-m.-h.)	m ³ /h	450-500-590-700	615-665-760-830
Dehumidification	l/h	1,3	2,3
Fan speeds	n°	Auto + 3 da telecomando	Auto + 3 da telecomando
Sound pressure (l.-l.-m.-h.)	dB(A)	24-26-30-37	35-40-46-49
Sound power (l.-l.-m.-h.)	dB(A)	32-34-38-45	43-48-54-57
Power supply	V/Ph/Hz	230/1/50	230/1/50
Power input	kW	0,037	0,075
Running current	A	0,17	0,33
Liquid pipe diameter	mm (")	6,35(1/4")	6,35(1/4")
Gas pipe diameter	mm (")	9,52(3/8")	12,7(1/2")
Net Weight	Kg	23,5	23,5
Net dimensions (H.-W.-D.)	mm	680x900x190	680/900/190



Units		SDIA S8	SDIB S9
Supported thermal load	kW	max 4 kW (iseries size A)	4-7 kW (iseries size B)
Air flowrate (l.-l.-m.-h.)	m ³ /h	300-340-380-470	470-520-600-680
Dehumidification	l/h	1,3	3,3
Fan speeds	n°	Auto + 3 by remote control	Auto + 3 by remote control
Sound pressure (l.-l.-m.-h.)	dB(A)	24-26-30-37	35-40-46-49
Sound power (l.-l.-m.-h.)	dB(A)	32-34-38-45	43-48-54-57
Power supply	V/Ph/Hz	230/1/50	230/1/50
Power input	kW	0,037	0,075
Running current	A	0,17	0,33
Liquid pipe diameter	mm (")	6,35(1/4")	6,35(1/4")
Gas pipe diameter	mm (")	9,52(3/8")	12,7(1/2")
Net Weight	Kg	25	25
Net dimensions (H.-W.-D.)	mm	585x890x190	585x890x190

Indoor Unit Technical Data



	Units	ASIA S8	ASIB S9
Supported thermal load	kW	max 4 kW (iseries size A)	4-7 kW (iseries size B)
Air flowrate I.U. (ll.-l.-m.-h.)	m³/h	470-500-600-700	500-530-630-750
Dehumidification	l/h	1,2	2,3
Fan speeds	n°	Auto + 3 by remote control	Auto + 3 by remote control
Sound pressure I.U. (ll.-l.-m.-h.)	dB(A)	35-37-40-44	35-37-40-44
Sound power I.U. (ll.-l.-m.-h.)	dB(A)	44-46-49-52	44-46-49-53
Power supply	V/Ph/Hz	230/1/50	230/1/50
Power input	kW	0,087	0,087
Running current	A	0,41	0,41
Liquid pipe diameter	mm (")	6,35(1/4")	6,35(1/4")
Gas pipe diameter	mm (")	9,52(3/8")	12,7(1/2")
Net Weight I.U. (+grille)	Kg	16,5 + 2,5	18 + 2,5
Net dimensions I.U. (H.-W.-D.)	mm	296x575x575	296x575x575
Net dimensions grille (H.-W.-D.)	mm	41x730x730	41x730x730

Notes:

Notes:



XFETTO



XFETTO[™]

Attractive, slim, versatile and... with no outdoor unit Xfetto can be fitted anywhere, even in the space under a window, instead of a radiator perhaps. This is because it works as a radiator as well as an air conditioner and dehumidifier... it also has no outdoor unit and is very easy to install!

Made of ABS with a high-gloss pearl finish, Xfetto has a modern yet linear design that fits well in any space.

XFETTO™ goodbye outdoor unit...

XFETTO AIR/AIR

2 holes in the wall are enough...

to connect the air-condensed Xfetto to the outside, as long as the holes are made in a perimeter wall.

Xfetto air/air houses the outdoor unit inside itself and in order to operate correctly requires a constant exchange of air with the outside because it uses air to cool the condenser. This air exchange takes place via two 16.2 cm holes (1 intake hole and 1 outflow hole), to be made in the installation wall, which therefore must be a perimeter wall.

Thanks to the special grilles the unit can be installed very easily even from inside the room, through walls or structures up to 2 metres thick or directly onto large windows with no loss of performance...

XFETTO is also designed to allow built-in wall installation and in this instance its visible depth is reduced to only 10 centimetres.

When Xfetto operates in cooling mode or dehumidification only, the condensation is released by internal evaporation on the condenser: therefore there is no need to provide a condensation discharge pipe for the cooling-only models.

The condensation discharge is however required for models with heat pump, even though its use is limited to heat pump operation. The condensation can be drawn into either the inside or outside of the room using the dedicated duct inside the chassis of the device.



Air condensed

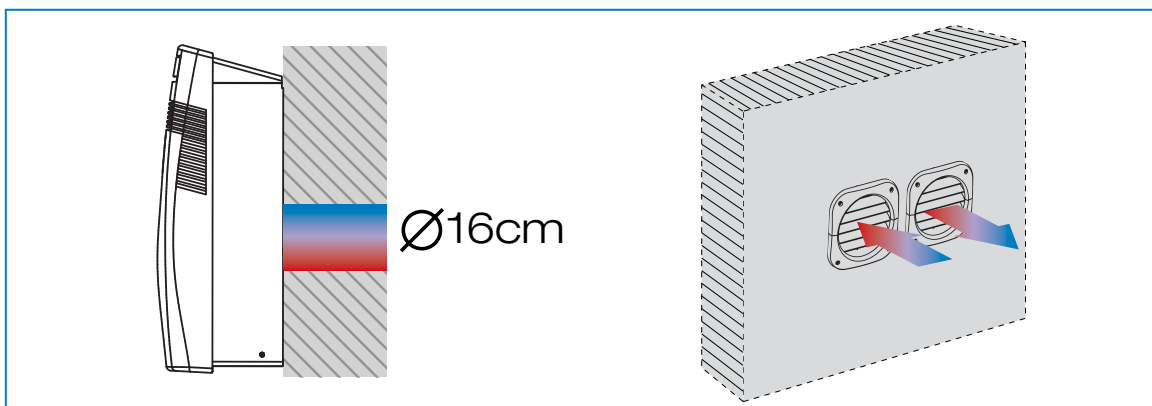
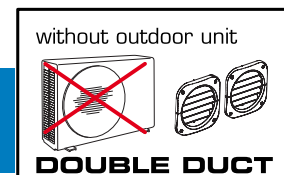

Xfetto eliminates the problem of the outdoor unit in two different ways that can brilliantly solve different problems and meet various different requirements.

XFETTO AIR/WATER

COP up to 4.68

Can also be installed on non-perimeter walls

Xfetto water-condensed still eliminates the problem of the outdoor unit by housing it inside, but uses water instead of air to cool the condenser. This solution provides the advantage of not requiring holes in the wall and thus allows the device to be installed on any type of wall, perimeter or not.

The advantages of this application include: great energy efficiency (COP up to 4.68), low power consumption (630 watts to achieve a thermal capacity of over 3 kW) and extremely quiet operation thanks to the fact that the condenser, being water-cooled, has no ventilation system.

Not only this, but the water-condensed version of Xfetto consumes just one cubic metre of water per day (less than one euro). Unique and special, it provides solutions for niche applications that arise much more often than you may think... From residences in historic buildings with large supplies of water, to systems with cooling towers, heat pumps and/or boilers on closed-circuit loops even when controlled by BMS, such as Lyon Airport...

Town water

The ideal application for areas with strict regulations governing modifications to building facades and without limitations on water use. The system nevertheless has a low level of water consumption that may reach up to one cubic metre of water per day under normal summer operating conditions, with a daily cost of less than one euro. It only needs to be connected to two water pipes, inlet and outlet.

Water loop

Xfetto can also operate as a terminal of a water loop system with water at 30°C in accordance with EN14511 specifications. The water used to cool the condenser is fed into a circuit and drawn to a cooling tower where it is cooled and then reused by the device.

Water condensed

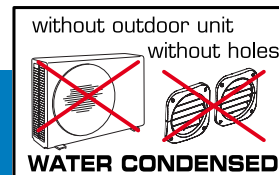

Town water

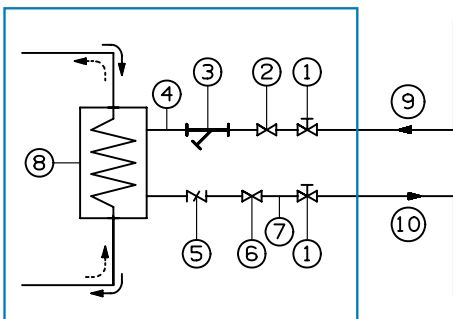

Water loop

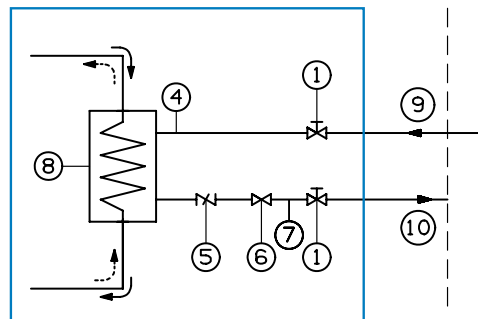

Legenda

- | | | |
|-----------------------------|------------------------------|----------------|
| ① Tap | ⑤ Flow | ⑨ Water inlet |
| ② Flow control valve | ⑥ Solenoid | ⑩ Water outlet |
| ③ Mechanical mesh filter | ⑦ Flexible pipe water outlet | |
| ④ Flexible pipe water inlet | ⑧ Water heat exchanger | |

A real advantage for on/off versions - whether air or water condensed - is the ability to connect Xfetto to a central heating system, or to use it as an autonomous air conditioner even under low ambient temperature conditions down to -15°C outdoors, in dwellings, containers, bunkers... Operates as a heater when connected to the heating system circuit using the dedicated hydraulic module (optional), which also includes a three-way bypass valve.

To use the heating function Xfetto must be connected to the central heating system, whether it is centralised or autonomous, as long as suitable checks have been carried out on the system to determine the water flow rate conditions in terms of volume and thermal capacity.

The connection can be made using the dedicated optional kit, which works as an interface module between xfetto and the central heating system. Without this kit, xfetto can still be installed with maximum flexibility as an air conditioner/heat pump without an outdoor unit (for example in places where there is no central heating system due to climatic reasons).

The connection kit to the central heating system is symmetrical and can be fitted on the left or right of the device. It is designed to adapt to various different existing situations (pipes to the right, pipes to the left, delivery on the right and return on the left, delivery above and return below...). This means that the same kit can be used for both sides. The size and shape of the kit elegantly covers the greater part of hydraulic connections and in addition the thickness of the plastic on the upper and lower parts has been reduced to facilitate adaptation to existing systems and make installation easier.

The kit is comprised of a plastic casing and all the components (electronic and hydraulic) required for radiator operation. The installer need only to make the hydraulic connections to the central heating system delivery and return pipes.

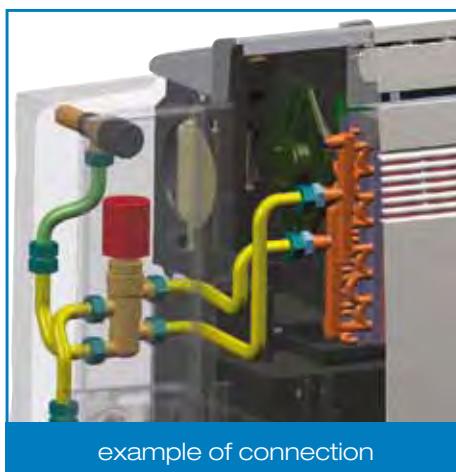



4 seasons

WINTER FUNCTION 

HYDRAULIC MODULE

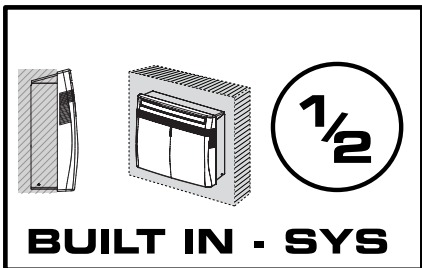

BUILT IN - SYS

News 2011



Over 3kW
Class AA



FULL DCI technology is the heart of the new **XFETTO DCI**, made in two different versions optimised for applications where there is a priority for either heating or cooling. It also offers maximum efficiency at maximum rotation with minimum electromagnetic noise and extremely precise speed control at low speeds. This provides the best torque control at low speeds and the refined control provides a true energy saving... It is much easier to reach the setpoint quickly than to keep it constant with minimum energy consumption...

The cooling capacity exceeds 3 kW for an energy efficiency class AA, but there are also many other features to highlight, such as: the extreme quietness, the minimum thermal load of less than 1000 watts, the special mini-rotary compressor, operation even in low outdoor temperatures both in heating and cooling modes...

EVEN QUIETER

Thanks to the special tangential fan, Xfetto has a high air flow rate but is still extremely quiet because it is fully lined with soundproofing material.

The **FULL DC INVERTER - SVPWM 180°** technology allows for the simultaneous modulation of all the main parameters: compressor capacity, fan speed and refrigerant flow. SVPWM180° modulation ensures maximum energy efficiency because it controls with sinusoidal current the rotation of the permanent-magnet synchronous motors through 360°.

Xfetto DCI is the optimum solution for 365 days a year: automatic, quiet, with low power consumption, it is very efficient and convenient in every circumstance, from historic buildings to shops, apartments, mobile units, containers for building sites, kiosks, newsstands...

available in 2011

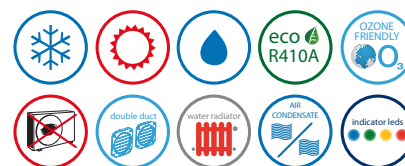

XFETTO AIR CONDENSED



245C cooling only
235H heat pump

XFETTO

- Installation on a perimeter wall
- Automatic switching from cooling to heating based on set temperature (235H)
- Operation as a radiator when connected to the heating system circuit using the dedicated hydraulic module (optional), which also includes a three-way bypass valve
- Remote control with digital 24h thermostat/timer and up to 4 addresses
- Dual temperature sensor (on unit and remote control)
- iFeel Function
- Night Function
- Horizontal deflector that can be switched between fixed and oscillating positions via remote control
- Variable speed of the condensing fan to reduce at minimum the external noise
- Tangential fan with three programmable or automatic speeds
- Device that prevents the infiltration of cold air into the room in heat pump mode during defrosting cycles (235H)
- Device that prevents the circulation of air in the room when the heating water temperature is below 40°C in heating mode
- Precision thermostat with settings from 6°C to 40°C in heating mode
- Auto restart following a power black out
- Electronic protection against overpressure
- High efficiency rotary compressor
- Optional feet for floor installation (windows, loft conversions...)

PRODUCT NAME		XFETTO 245C	XFETTO 235H	
Features	Units	Cooling	Cooling	Heating
	kW	2,45	2,35	2,25
Cooling/Heating capacity (A/Conditioner mode)	BTU/h	8.360	8.020	7.700
	kcal/h	2.110	2.020	1.935
Heating capacity (Water Radiator mode)	kW	2,10	2,10	
Energy label class	ABCDEFGF	A	A	C
E.E.R. / C.O.P.	(kW/kW)	2,62	2,61	2,65
Air flowrate (h.-m.-l.)	m ³ /h	330-300-280		
Dehumidification	l/h	1,2	1,0	
Fan speeds	n°	3 + Auto		
Sound pressure in Air/Conditioner mode (h.-m.-l.)	dB(A)	45-43-41		
Sound pressure in Water radiator mode (h.-m.-l.)	dB(A)	42-39-32		
Power supply	V/Ph/Hz	230/1/50		
Running consumption in Air/Conditioner mode	kW	0,935	0,900	0,850
Annual energy cons.- A/C(500h)-Directive 2002/31/EC	kWh	468	450	-
Running consumption in Water radiator mode	kW	0,027	0,027	
Refrigerant type		R410A		
Ducts diameter	mm	162		
Hydraulic connection diameter on the heating plant (W.R.mode)	inch	1/2"		
Condensate discharge		not requested	by duct, outside or inside the room	
Condensate drain connection diameter (outside)	mm	18		
Net weight	Kg	50		
Net dimensions (H./W./D.)	mm	735/839/260-280		

The technical data here indicated are in compliance with the European standard EN14511 - Directive 2002/31/EC

Argo Xfetto is protected by patent N. 261412 issued to Argoclima S.p.A. on 8th Jan, 2009

XFETTO WATER CONDENSED



245SCH₂O cooling only
235HPH₂O heat pump

- Can be installed on any wall, even non-perimeter walls, because it does not require holes in the wall
- Designed to work with town water or well/groundwater source, it can also operate as a terminal in a closed circuit water loop system with water at 30°C in accordance with EN14511 specifications.
- Very high levels of efficiency (EER up to 4.68)
- Automatically switches from cooling to heating based on set temperature (235HP)
- Operates as a radiator when connected to the heating system circuit using the dedicated hydraulic module (optional), which also includes a three-way bypass valve
- High efficiency plate heat exchanger with solenoids to cut off the circulation of town water when the compressor is off
- Antifreeze protection on condensation water circuit
- Installation of a serviceable filter on the town water inlet (to be carried out by installer) recommended
- Remote control with digital 24h thermostat/timer and up to 4 addresses
- Dual temperature sensor (on unit and remote control)
- Dry Functions; Fan Only; iFeel; Night
- Horizontal deflector that can be switched between fixed and oscillating positions via remote control
- Washable air filters
- Tangential fan with three programmable or automatic speeds
- Device that prevents the infiltration of cold air into the room, in heat pump mode (235HP)
- Device that prevents the circulation of air in the room when the heating water temperature is below 40°C in heating mode
- Precision thermostat with settings from 6°C to 40°C in heating mode
- Auto restart following a power black out
- Electronic protection against overpressure
- High efficiency rotary compressor covered by a 5-year warranty
- Optional feet for floor installation (windows, loft conversions...)

PRODUCT NAME	XFETTO 245SCH ₂ O				XFETTO 235HPH ₂ O			
	Town water		Water loop[*]		Town water		Water loop[*]	
Operation	Raffreddamento							
Features	Units		Raffreddamento		Raffr.		Risc.	
Cooling/Heating capacity (Air-Conditioner mode)	kW		2,83	2,7	2,95	3,15	3,00	3,56
	BTU/h		9.650	9.200	10.060	10.740	10.230	12.140
	kcal/h		2.430	2.320	2.540	2.710	2.580	3.060
Energy label class	ABCDEFGF		B		-		A C	
E.E.R. / C.O.P.	(kW/kW)		4,42	4,15	4,68	3,80	4,41	4,14
Air flowrate (h.-m.-l.)	m³/h		330-300-280		330-300-280		330-300-280	
Dehumidification	litri/h		1,2		1,3		1,3	
Fan speeds	n°		3 + Auto		3 + Auto		3 + Auto	
Sound pressure in Air-Conditioner mode (h.-m.-l.)	dB(A)		44-42-41		44-42-41		44-42-41	
Power supply	V/Ph/Hz		230/1/50		230/1/50		230/1/50	
Running consumption in Air-Conditioner mode	kW		0,640	0,650	0,630	0,830	0,680	0,860
Annual energy cons.- A/C(500h)-Directive 2002/31/EC	kWh		-		-		340	
Water flowrate for the heat exchanger	m³/h		0,150		0,150		0,525	
Pressure drops	KPa		2,9		38,0		40,3	
Refrigerant type			R410A		R410A		R410A	
Water connection diameter (in/out)	inch		1/2" [gas] F		1/2" [gas] F		1/2" [gas] F	
Condensate drain connection diameter (inside or outside)	mm		13/18		13/18		13/18	
Heat transferred to water	kW		3,47		3,58		3,68	
Heat moved from water	kW		-		-		2,7	
Heating capacity in Water Radiator mode	kW		2,1		-		2,1	
Running consumption in Water radiator mode	kW		0,027		-		0,027	
Water flowrate in Water Radiator mode	m³/h		0,19		-		0,19	
Pressure drops in Water Radiator mode	kPa		2,9		-		2,9	
Hydraulic connection diameter to the heating plant (W.R.mode)	inch		1/2" F		-		1/2" [gas] F	
Sound pressure in Water radiator mode (h.-m.-l.)	dB(A)		42-39-32		-		42-39-32	
Net weight	Kg		46		-		48	
Net dimensions (H./W./D.)	mm		735/839/260-280		-		735x839x260-280	

water loop: standard conditions EN14511

Town water - Cooling: Room Temp. 27°C d.b. / 19°C w.b. - Water Temp.: inlet 18°C - outlet 36°C / Heat Pump: Room Temp. 20°C d.b. - Water Temp.
Water loop - Cooling: Room Temp. 27°C d.b. / 19°C w.b. - Water Temp.: inlet 30°C - outlet 35°C / Heat Pump: Room Temp. 20°C d.b. - Water Temp.
Water radiator - Room Temp. 20°C - Water Temp.: inlet 70°C - outlet 60°C

Argo Xfetto is protected by patent N. 261412 issued to Argoclima S.p.A. on 8th Jan, 2009

SPLIT/PACKAGE DCI



SPLIT/PACKAGE DCI



DCI

Split & package DC Inverter up to 14 kW of thermal capacity for single and multi applications, for high-wall, floor/ceiling or built-in type (cassette and ducted)

MONOSPLIT DC INVERTER

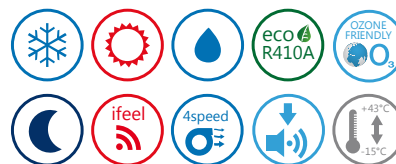

AWI 726

- FULL DC Inverter technology – SVPWM 180°, with contemporary modulation of all basic parameters: compressor capacity, outdoor unit fan speed and refrigerant flow
- Sound pressure just over 20 dB(A), near the setpoint.
- C.O.P. over 4: beyond AA class
- Minimum consumption near comfort conditions below 300W.
- Less than 1W consumption in stand-by mode
- Easy life for the installer: maximum flexibility of installation; condensate discharge on the right or on the left
- Digital remote control with double infrared wide range transmitters and sensor incorporated
- «ifeel» as default feature: the comfort just in the exact point in which the remote control is placed
- «Progressive Cooling», to have the desired fresh with softness
- «High Power», the “turbo” feature to have immediately the maximum cooling or heating
- Washable filters and active carbon filters (optional)
- Temperature regulation from 10°C to 32°C, both in cooling and heating modes
- “Economy & Night”, to further reduce the energy consumption
- “i-Flap”, automatic intelligent management of the flap, according to the cooling or heating mode, for the airflow optimization
- “Multi-addressing”, to manage with a single remote control up to 4 indoor units installed in the same room
- No stop operation in heating during defrost (SHN models)
- Electrical protections on both indoor and outdoor units
- Totally insulated compressor with a special sound-absorbing material, for maximum silence even at maximum rpm

MATCHING		AWI726HQ	
Indoor unit		AWI726HLQ	
Outdoor unit		AEI726SHQ/SHNQ	
Features	Units	Cooling	Heating
Cooling/Heating capacity nominal (min.-max.)	kW	2,85 (1,05-3,15)	3,24 (1,15-4,0)
Energy label class	ABCDEFGH	A	A
E.E.R. /C.O.P. nominal (min.-max.)	(kW/kW)	3,65 (4,57-2,86)	4,10 (5,48-3,20)
Air flowrate Indoor (h.-m.-l.)	m ³ /h	450-400-370	
Dehumidification	l/h	1,2	-
Fan speeds (Indoor / Outdoor)	n°	4/auto	
Sound pressure Indoor (h.-m.-l.-sl.)	dB(A)	39-36-29-23	
Sound pressure Outdoor (max.)	dB(A)	37	
Power supply	V/Ph/Hz	230/1/50	
Power input nominal (min.-max.)	kW	0,78 (0,23-1,1)	0,79 (0,21-1,25)
Annual energy cons.- cooling mode (500h) - Directive 2002/31/CE	kWh	390	-
Compressor type		Rotary	
Refrigerant type		R410A	
Liquid pipe diameter	mm(inch")	6,35(1/4")	
Gas pipe diameter	mm(inch")	9,52(3/8")	
Max. pipe lenght with gas standard charge	m	7,5	
Max. pipe lenght with gas additional charge	m	15	
Gas additional charge	gr/m	15	
Max. height between units (Outdoor on top)	m	7	
Max. height between units (Indoor on top)	m	7	
Net weight Indoor / Outdoor	Kg	8/35	
Net dimension Indoor (H./W./D.)	mm	270x805x215	
Net dimension Outdoor (H./W./D.)	mm	540x700x265	

The technical data here indicated are in compliance with the European standard EN14511 - Directive 2002/31/EC

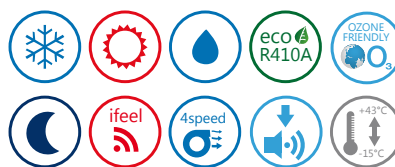

AWI 735

- FULL DC Inverter technology – SVPWM 180°, with contemporary modulation of all basic parameters: compressor capacity, outdoor unit fan speed and refrigerant flow
- Sound pressure just over 20 dB(A), near the setpoint.
- C.O.P. over 4: beyond AA class
- Minimum consumption near comfort conditions below 300W.
- Less than 1W consumption in stand-by mode
- Easy life for the installer: maximum flexibility of installation; condensate discharge on the right or on the left
- Digital remote control with double infrared wide range transmitters and sensor incorporated
- «ifeel» as default feature: the comfort just in the exact point in which the remote control is placed
- «Progressive Cooling», to have the desired fresh with softness
- «High Power», the “turbo” feature to have immediately the maximum cooling or heating
- Washable filters and active carbon filters (optional)
- Temperature regulation from 10°C to 32°C, both in cooling and heating modes
- “Economy & Night”, to further reduce the energy consumption
- “i-Flap”, automatic intelligent management of the flap, according to the cooling or heating mode, for the airflow optimization
- “Multi-addressing”, to manage with a single remote control up to 4 indoor units installed in the same room
- No stop operation in heating during defrost (SHN models)
- Electrical protections on both indoor and outdoor units
- Totally insulated compressor with a special sound-absorbing material, for maximum silence even at maximum rpm

MATCHING		AWI735HQ	
Indoor unit		AWI735HLQ	
Outdoor unit		AEI735SHQ/SHNQ	
Features	Units	Cooling	Heating
Cooling/Heating capacity nominal (min.-max.)	kW	3,25 [1,1-3,7]	3,40 [1,25-4,65]
Energy label class	ABCDEFGH	A	A
E.E.R. /C.O.P. nominal (min.-max.)	(kW/kW)	3,32 [4,4-2,78]	3,82 [5,21-3,0]
Air flowrate Indoor (h.-m.-l.)	m ³ /h	470-430-390	
Dehumidification	l/h	1,5	-
Fan speeds (Indoor / Outdoor)	n°	4/auto	
Sound pressure Indoor (h.-m.-l.-sl.)	dB(A)	39-36-29-23	
Sound pressure Outdoor (max.)	dB(A)	40	
Power supply	V/Ph/Hz	230/1/50	
Power input nominal (min.-max.)	kW	0,98 [0,25-1,33]	0,89 [0,24-1,55]
Annual energy cons.- cooling mode (500h) - Directive 2002/31/CE	kWh	490	-
Compressor type		Rotary	
Refrigerant type		R410A	
Liquid pipe diameter	mm(inch")	6,35(1/4")	
Gas pipe diameter	mm(inch")	9,52(3/8")	
Max. pipe lenght with gas standard charge	m	7,5	
Max. pipe lenght with gas additional charge	m	15	
Gas additional charge	gr/m	15	
Max. height between units (Outdoor on top)	m	7	
Max. height between units (Indoor on top)	m	7	
Net weight Indoor / Outdoor	Kg	8 / 35	
Net dimension Indoor (H./W./D.)	mm	270x805x215	
Net dimension Outdoor (H./W./D.)	mm	540x700x265	

The technical data here indicated are in compliance with the European standard EN14511 - Directive 2002/31/EC

quadri: AE4MI80AH/B

cool: 8 kW - heat: 9,4 kW



dual/trial: AE3MI56AH

cool: 5,6 kW - heat: 7,3 kW

trial: AE3MI68AH/B

cool: 6,8 kW - heat: 8,6 kW



- Cooling only and heat pump Multisplit systems, the ideal solution to provide comfortable conditions to 2, 3 or 4 rooms from one only outdoor unit
- 3 capacities: from 5,6 to 9,4 kW
- DC Inverter technology - R410A
- A class: all Multisplits are rated in the best Energy Efficiency Class thanks to:
 - last generation Twin rotary compressor: perfectly balanced dual rotors revolve smoothly and efficiently to provide powerful and vibration-free performance
 - power consumption during operation is reduced to minimum and consequently also full life cycle costs
- Fast and precise temperature control thanks to the Advanced Digital Hybrid (ADH) technology: the DC compressor operates at maximum power to provide almost instant heating or cooling and when desired temperature is reached a special Pulse Width Module automatically adjusts the compressor frequency so that to meet the room cooling or heating requirements.
- Maximum flexibility for installation: up to 70 m of pipe length
- Heating no-stop system: avoid heating stop due to defrosting cycles
- Fully mixed matching possibility of the indoor units (high-wall, cassette, ducted, floor and floor/ceiling)
- Each indoor unit is managed by its own full function remote control, with temperature sensor inside, 1h and 24h timers, operation mode selection, fan speed control, temperature setting
- "LED clean" feature, LED photocatalytic sterilization against odours, germs and bacteria (flat wall indoor units)
- In case more indoor units are installed in the same room, it is possible to address each remote control to its own indoor unit only, so that to avoid any interference
- Auto restart after a power supply black out
- It works with at least two indoor units connected
- Single-phase power supply 230/1/50
- Electronic protection against over-pressures

PRODUCT NAME		AE3MI56AH		AE3MI68AH/B		AE4MI80AH/B	
Outdoor unit							
Features	Units	Cooling	Heating	Cooling	Heating	Cooling	Heating
No. of Indoor units operating simultaneously	n°	3		3		4	
Minimum no. of connectable indoor units	n°	2		2		2	
Cooling/Heating capacity - nominal (min-max)	kW	5,2 (2,9-6,5)	6,8 (3,4-7,8)	6,8 (2,9-8,1)	8,6 (3,4-9,0)	8,0 (2,9-9,2)	9,4 (3,4-9,8)
Energy label class	ABCDEFGF	A		A		A	
E.E.R. / C.O.P.	(kW/kW)	3,40	4,22	3,40	4,30	4,64	4,61
Air flowrate Outdoor (h.-m.-l.)	m³/h	2900-1780-1310		2900-1780-1310		3070-1850-1400	
Fan speeds Outdoor	n°	Auto		Auto		Auto	
Sound pressure Outdoor (h.) at 4 m distance	dB(A)	47	48	50	52	53	54
Power supply	V/Ph/Hz	230/1/50		230/1/50		230/1/50	
Running consumption	kW	1,530	1,610	2,0	2,0	1,725	2,040
Running current	A	6,88	7,70	8,87	8,87	7,58	8,96
Annual energy cons.-cooling(500h)-Dir.2002/31/CE	kWh	765	-	1.000	-	862,5	-
Compressor type		Twin Rotary (DC inverter)		Twin Rotary (DC inverter)		Twin Rotary (DC inverter)	
Refrigerant type		R410A		R410A		R410A	
Liquid pipe diameter	mm(inch")	6,35(1/4") x 3 (2)		6,35(1/4") x 3		6,35(1/4") x 4	
Gas pipe diameter	mm(inch")	9,52(3/8") x 3 (2)		9,52(3/8") x 3		9,52(3/8")x3 - 12,7(1/2")x1	
Max. pipe lenght (per indoor unit)	m	25		25		30	
Total max. pipe lenght (per indoor unit)	m	45		60		70	
Total pipe lenght with standard charge	m	45		45		45	
Gas additional charge	gr/m	not requested		20		20	
Max. height between units (Outdoor on top)	m	15		15		15	
Max. height between units (Indoor on top)	m	15		15		15	
Net weight Outdoor	Kg	65		65		82	
Net dimension Outdoor (H./W./D.)	mm	740x900x320		740x900x320		890x900x320	

The technical data here indicated are in compliance with the European standard EN14511 - Directive 2002/31/EC

Indoor units



HIGH-WALL
2.2 - 2.7 - 3.5 kW



HIGH-WALL
5.2 - 6.8 kW



CASSETTE



DUCTED



FLOOR/CEILING



FLOOR

Indoor units table

Hi-wall units						
	Air flowrate (h.) (cooling/heating)	Dry	Fan speeds	Sound pressure (silent- L-m.-h.)	Dimension (HxWxD)	Net weight
AWMI22AHLF	m ³ /h 440 / 480	U/h 1,3	4 + Auto	dB(A) 22-27-30-33	mm 285x825x189	kg 10
AWMI27AHLF	m ³ /h 460 / 480	U/h 1,6	4 + Auto	dB(A) 22-28-31-34	mm 285x825x189	kg 10
AWMI35AHLF	m ³ /h 480 / 500	U/h 2,0	4 + Auto	dB(A) 25-29-33-36	mm 285x825x189	kg 10
AWI52AHLF	m ³ /h 840 / 880	U/h 2,3	4 + Auto	dB(A) 28-34-38-41	mm 298x1065x234	kg 12
AWI68AHLF	m ³ /h 890 / 930	U/h 2,3	4 + Auto	dB(A) 30-38-41-44	mm 298x1065x234	kg 12

Cassette units						
	Air flowrate (L.-m.-h.)	Dry	Fan speeds	Sound pressure (L.- m.-h.)	Dimension (HxWxD)	Net weight
ASMI27HG	m ³ /h 500-600-700	U/h 1,5	3 + Auto	dB(A) 37-40-44	mm 296x575x575	kg 16,5
ASMI35HG	m ³ /h 500-600-700	U/h 1,8	3 + Auto	dB(A) 37-40-44	mm 296x575x575	kg 16,5
ASJ55AHL	m ³ /h 580-660-790	U/h 2,0	3 + Auto	dB(A) 37-40-45	mm 296x575x575	kg 18,0
ASGM28HG (grille)	-	-	-	-	mm 41x730x730	kg 2,5

Ducted units						
	Air flowrate (L.-m.-h.)	Dry	Fan speeds	Sound pressure (L.-m.- h.)	Dimension (HxWxD)	Net weight
ADM127HG	m ³ /h 470-560-620	U/h 1,5	3 + Auto	dB(A) 40-43-45	mm 266x926x571	kg 30,0
ADM135HG	m ³ /h 470-560-620	U/h 1,8	3 + Auto	dB(A) 40-43-45	mm 266x926x571	kg 30,0
2-way duct (200 mm each) Plenum	-	-	-	-	mm 266x926x200	kg 6,0
ADI55AHL	m ³ /h 455-645-865	U/h 2,0	3 + Auto	dB(A) 33-38-45	mm 266x1132x571	kg 35,0
ADI70AHL	m ³ /h 530-760-985	U/h 2,5	3 + Auto	dB(A) 37-40-48	mm 266x1132x571	kg 35,0
3-way duct (200 mm each) Plenum	-	-	-	-	mm 266x1132x200	kg 7,5

Floor & Floor/ceiling units						
	Air flowrate (L.-m.-h.)	Dry	Fan speeds	Sound pressure (L.- m.-h.)	Dimension (HxWxD)	Net weight
AFMI27HG	m ³ /h 320-390-425	U/h 1,6	3 + Auto	dB(A) 34-40-43	mm 700x560x200	kg 18,6
FCMI35HG	m ³ /h 500-590-700	U/h 2,0	3 + Auto	dB(A) 38-43-47	mm 680x900x190	kg 23,5
FCI55AHL	m ³ /h 515-615-720	U/h 2,8	3 + Auto	dB(A) 39-44-48	mm 680x900x190	kg 23,5
FCI70AHL	m ³ /h 650-800-900	U/h 3,4	3 + Auto	dB(A) 44-47-50	mm 680x900x190	kg 23,5

NB: For the indoor units capacity see the matching table.

Pipe lines tables

DUAL/TRIAL

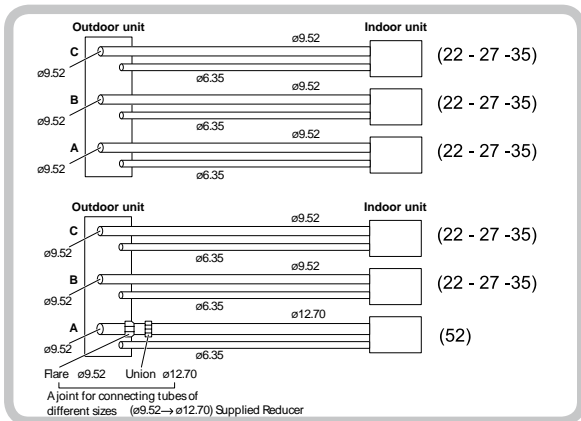

TRIAL

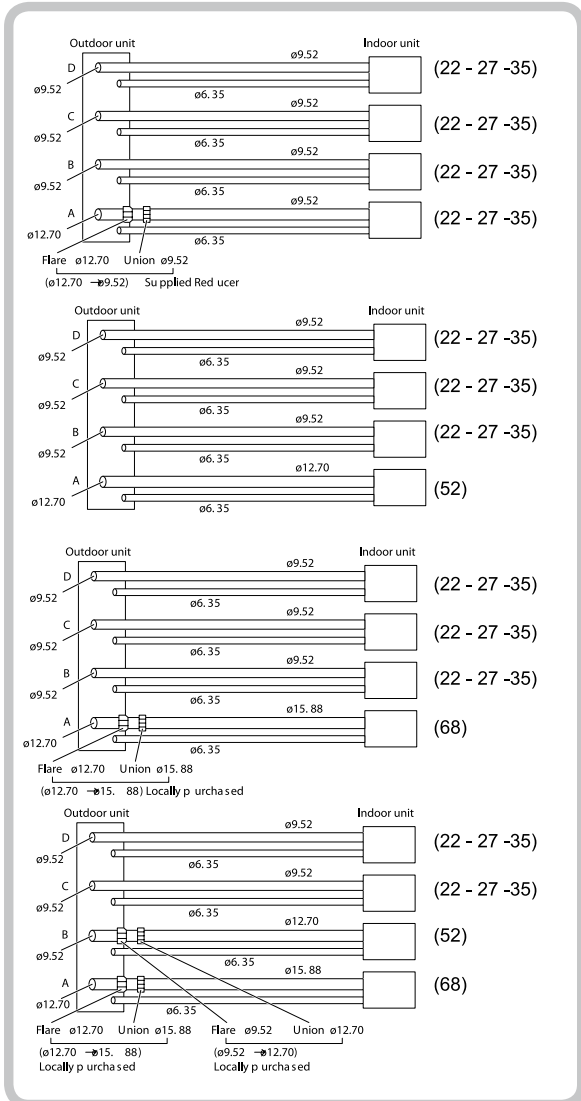

QUADRI

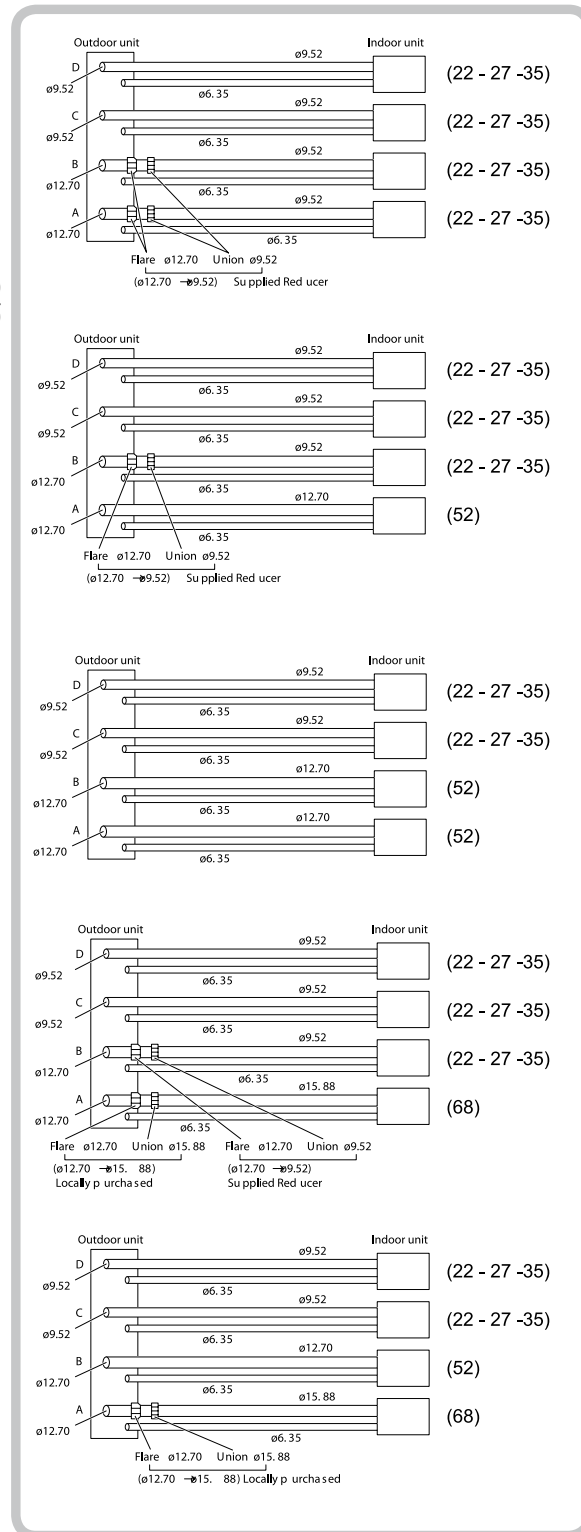

SPLIT/PACKAGE DCI

Note: Trial outdoor unit allows up to 4 indoor units to be connected. However, only three indoor units can operate simultaneously.

Indoor Units Matchings

OUTDOOR UNIT MODEL		AE3MI56AHB												
Performance		Cooling					Heating							
		Indoor unit capacity (kW)			Total capacity (min.-max.)	Power input (min.-max.)	EER	Indoor unit capacity (kW)			Total capacity (min.-max.)	Power input (min.-max.)	COP	
		A	B	C	kW	kW		A	B	C	kW	kW		
Matchable i.u. 22=AWMI22AHL/F 27=AWMI27AHL/F 35=AWMI35AHL/F 52=AWI52AHL/F	1 unit	22	2,20	-	-	2,20 [1,4-2,6]			2,50	-	-	2,50 [1,8-4,3]		
		27	2,65	-	-	2,65 [1,4-3,2]			3,60	-	-	3,60 [1,8-4,7]		
		35	3,50	-	-	3,50 [1,5-3,6]			4,20	-	-	4,20 [1,9-5,1]		
		52	5,15	-	-	5,15 [1,6-5,8]			6,00	-	-	6,00 [2,0-7,8]		
		22+22	2,20	2,20	-	4,40 [2,0-5,1]	1,28 [0,81-1,80]	3,44	2,50	2,50	-	5,00 [2,0-6,4]	1,18 [0,75-1,79]	4,24
	2 units	22+27	2,20	2,65	-	4,85 [2,0-5,8]	1,37 [0,81-1,98]	3,54	2,50	3,60	-	6,10 [2,1-7,5]	1,57 [0,75-2,32]	3,89
		22+35	1,97	3,13	-	5,10 [2,0-6,7]	1,44 [0,81-2,56]	3,54	2,40	3,90	-	6,30 [2,1-8,3]	1,65 [0,75-2,72]	3,82
		22+52	1,65	3,85	-	5,50 [2,1-6,8]	1,55 [0,82-2,26]	3,55	2,03	4,87	-	6,90 [2,4-8,4]	1,67 [0,68-2,27]	4,13
		27+27	2,50	2,50	-	5,00 [2,0-6,3]	1,39 [0,81-2,29]	3,60	3,20	3,20	-	6,45 [2,3-8,4]	1,68 [0,75-2,72]	3,84
		27+35	2,24	2,96	-	5,20 [2,1-6,8]	1,46 [0,81-2,55]	3,56	3,07	3,58	-	6,65 [2,3-8,4]	1,735 [0,75-2,72]	3,83
		27+52	1,90	3,70	-	5,60 [2,1-6,8]	1,695 [0,82-2,26]	3,30	2,74	4,56	-	7,30 [2,4-8,4]	1,735 [0,68-2,27]	4,21
		35+35	2,70	2,70	-	5,40 [2,0-6,8]	1,59 [0,81-2,55]	3,40	3,45	3,45	-	6,90 [2,3-8,4]	1,82 [0,75-2,72]	3,79
		35+52	2,27	3,33	-	5,60 [2,1-6,8]	1,695 [0,82-2,26]	3,30	3,01	4,29	-	7,30 [2,4-8,4]	1,735 [0,68-2,27]	4,21
		22+22+22	1,77	1,77	1,77	5,30 [2,5-9,9]	1,34 [0,82-2,38]	3,96	2,18	2,18	2,18	6,55 [2,7-8,4]	1,47 [0,68-2,30]	4,46
		22+22+27	1,69	1,69	2,03	5,40 [2,9-7,0]	1,37 [0,82-2,38]	3,94	2,02	2,02	2,91	6,95 [3,0-8,4]	1,60 [0,68-2,30]	4,34
		22+22+35	1,56	1,56	2,48	5,60 [2,9-7,2]	1,47 [0,81-2,25]	3,81	1,94	1,94	3,26	7,15 [3,2-8,4]	1,62 [0,68-2,30]	4,41
		22+22+52	1,29	1,29	3,02	5,60 [2,9-7,2]	1,48 [0,83-2,38]	3,78	1,66	1,66	3,98	7,30 [3,4-8,4]	1,735 [0,68-2,30]	4,21
		22+27+27	1,63	1,96	1,96	5,55 [2,9-7,2]	1,36 [0,82-2,38]	4,08	1,88	2,71	2,71	7,30 [3,4-8,4]	1,735 [0,68-2,30]	4,21
		22+27+35	1,48	1,78	2,35	5,60 [2,9-7,2]	1,55 [0,82-2,25]	3,61	1,77	2,55	2,98	7,30 [3,4-8,4]	1,735 [0,68-2,30]	4,21
		22+27+52	1,23	1,48	2,88	5,60 [2,9-7,2]	1,55 [0,83-2,38]	3,61	1,51	2,17	3,62	7,30 [3,4-8,4]	1,735 [0,68-2,30]	4,21
	22+35+35	1,34	2,13	2,13	5,60 [2,9-7,2]	1,55 [0,82-2,38]	3,61	1,67	2,81	2,81	7,30 [3,4-8,4]	1,735 [0,68-2,30]	4,21	
	27+27+27	1,87	1,87	1,87	5,60 [2,9-7,2]	1,55 [0,82-2,38]	3,61	2,43	2,43	2,43	7,30 [3,4-8,4]	1,735 [0,68-2,30]	4,21	
	27+27+35	1,69	1,69	2,23	5,60 [2,9-7,2]	1,55 [0,82-2,38]	3,61	2,31	2,31	2,69	7,30 [3,4-8,4]	1,735 [0,68-2,30]	4,21	
	27+35+35	1,54	2,03	2,03	5,60 [2,9-7,2]	1,55 [0,82-2,38]	3,61	2,19	2,56	2,56	7,30 [3,4-8,4]	1,735 [0,68-2,30]	4,21	
	35+35+35	1,87	1,87	1,87	5,60 [2,9-7,2]	1,55 [0,82-2,38]	3,61	2,43	2,43	2,43	7,30 [3,4-8,4]	1,735 [0,68-2,30]	4,21	

OUTDOOR UNIT MODEL		AE3MI68AH/B													
Performance		Cooling					Heating								
		Indoor unit capacity (kW)			Total capacity (min.-max.)	Power input (min.-max.)	EER	Indoor unit capacity (kW)			Total capacity (min.-max.)	Power input (min.-max.)	COP		
		A	B	C	kW	kW		A	B	C	kW	kW			
Matchable i.u. 22=AWMI22AHL/F 27=AWMI27AHL/F 35=AWMI35AHL/F 52=AWI52AHL/F	1 unit	22	2,20	-	-	2,20 [1,4-2,6]			2,50	-	-	2,50 [1,8-4,3]			
		27	2,65	-	-	2,65 [1,4-3,2]			3,60	-	-	3,60 [1,8-4,7]			
		35	3,50	-	-	3,50 [1,5-3,6]			4,20	-	-	4,20 [1,9-5,1]			
		52	5,15	-	-	5,15 [1,6-5,8]			6,00	-	-	6,00 [2,0-7,8]			
		68	6,80	-	-	6,80 [1,6-6,8]			8,00	-	-	8,00 [2,0-8,0]			
	2 units	22+22	2,20	2,20	-	4,40 [2,0-5,1]			2,50	2,50	-	5,00 [2,0-6,4]			
		22+27	2,20	2,50	-	4,85 [2,0-5,8]			2,50	3,60	-	6,10 [2,1-7,5]			
		22+35	2,20	3,50	-	5,70 [2,0-6,7]			2,50	4,20	-	6,70 [2,1-8,3]			
		22+52	1,98	4,62	-	6,60 [2,1-7,7]			2,44	5,86	-	8,30 [2,4-9,0]			
		22+68	1,61	5,19	-	6,80 [2,1-8,1]			1,95	6,65	-	8,60 [2,4-9,0]			
		27+27	2,65	2,65	-	5,30 [2,0-6,3]			3,60	3,60	-	7,20 [2,3-8,5]			
		27+35	2,54	2,54	-	5,90 [2,0-6,8]			3,51	4,09	-	7,60 [2,3-8,5]			
		27+52	2,28	4,42	-	6,70 [2,1-8,1]			3,15	5,25	-	8,40 [2,4-9,0]			
		27+68	1,85	4,95	-	6,80 [2,1-8,1]			2,56	6,04	-	8,60 [2,4-9,0]			
		35+35	3,30	3,30	-	6,60 [2,0-8,1]			4,00	4,00	-	8,00 [2,3-8,5]			
		35+52	2,75	4,05	-	6,80 [2,1-8,1]			3,50	5,00	-	8,50 [2,4-9,0]			
		35+68	2,25	4,55	-	6,80 [2,1-8,1]			2,84	5,76	-	8,60 [2,4-9,0]			
		52+52	3,40	3,40	-	6,80 [2,1-8,1]			4,30	4,30	-	8,60 [2,4-9,0]			
		3 units	22+22+22	2,20	2,20	2,20	6,50 [2,5-7,7]	2,00 [0,82-2,57]	3,25	2,50	2,50	2,50	7,50 [2,7-8,5]	1,78 [0,68-2,3]	4,21
			22+22+27	2,06	2,06	2,48	6,60 [2,9-8,1]	2,00 [0,82-2,6]	3,30	2,30	2,30	2,30	8,00 [3,0-9,0]	1,87 [0,68-2,46]	4,28
	22+22+35		1,88	1,88	2,99	6,75 [2,9-8,1]	2,00 [0,82-2,6]	3,38	2,26	2,26	3,79	8,30 [3,2-9,0]	2,00 [0,68-2,46]	4,15	
	22+22+52		1,57	1,57	3,67	6,80 [2,9-8,1]	2,00 [0,83-2,6]	3,40	1,95	1,95	4,69	8,60 [3,4-9,0]	2,00 [0,69-2,46]	4,30	
	22+27+27		1,97	2,40	2,40	6,70 [2,9-8,1]	2,00 [0,82-2,6]	3,35	2,16	3,12	3,12	8,40 [3,4-9,0]	2,00 [0,68-2,46]	4,20	
	22+27+35		1,79	2,16	2,85	6,80 [2,9-8,1]	2,00 [0,82-2,6]	3,40	2,06	2,97	3,47	8,50 [3,4-9,0]	2,00 [0,68-2,46]	4,25	
	22+27+52		1,50	1,80	3,50	6,80 [2,9-8,1]	2,00 [0,83-2,6]	3,40	1,78	2,56	4,26	8,60 [3,4-9,0]	2,00 [0,69-2,46]	4,30	
	22+35+35		1,63	2,59	2,59	6,80 [2,9-8,1]	2,00 [0,82-2,6]	3,40	1,97	3,31	3,31	8,60 [3,4-9,0]	2,00 [0,68-2,46]	4,30	
	22+35+52		1,38	2,19	3,23	6,80 [2,9-8,1]	2,00 [0,83-2,6]	3,40	1,69	2,84	4,06	8,60 [3,4-9,0]	2,00 [0,69-2,46]	4,30	
	27+27+27		2,27	2,27	2,27	6,80 [2,9-8,1]	2,00 [0,82-2,6]	3,40	2,87	2,87	2,87	8,60 [3,4-9,0]	2,00 [0,68-2,46]	4,30	
	27+27+35		2,05	2,05	2,70	6,80 [2,9-8,1]	2,00 [0,82-2,6]	3,40	2,72	2,72	3,17	8,60 [3,4-9,0]	2,00 [0,68-2,46]	4,30	
	27+27+52		1,72	1,72	3,35	6,80 [2,9-8,1]	2,00 [0,83-2,6]	3,40	2,35	2,35	3,91	8,60 [3,4-9,0]	2,00 [0,69-2,46]	4,30	
27+35+35	1,87		2,47	2,47	6,80 [2,9-8,1]	2,00 [0,82-2,6]	3,40	2,58	3,01	3,01	8,60 [3,4-9,0]	2,00 [0,68-2,46]	4,30		
27+35+52	1,59		2,11	3,10	6,80 [2,9-8,1]	2,00 [0,83-2,6]	3,40	2,24	2,62	3,74	8,60 [3,4-9,0]	2,00 [0,68-2,46]	4,30		
35+35+35	2,27		2,27	2,27	6,80 [2,9-8,1]	2,00 [0,82-2,6]	3,40	2,87	2,87	2,87	8,60 [3,4-9,0]	2,00 [0,68-2,46]	4,30		
35+35+52	1,96	1,96	2,88	6,80 [2,9-8,1]	2,00 [0,83-2,6]	3,40	2,51	2,51	3,58	8,60 [3,4-9,0]	2,00 [0,69-2,46]	4,30			

Indoor Units Matchings

OUTDOOR UNIT MODEL		AE4M180AH/B													
Performance		Cooling						Heating							
		Indoor unit capacity (kW)				Total capacity (min.-max.)	Power input (min.-max.)	EER	Indoor unit capacity (kW)				Total capacity (min.-max.)	Power input (min.-max.)	COP
		A	B	C	D	kW			A	B	C	D	kW	kW	
1 unit	22	2,20	-	-	-	2,20 (1,5-2,6)			2,50	-	-	-	2,50 (1,8-4,3)		
	27	2,65	-	-	-	2,65 (1,5-3,2)			3,60	-	-	-	3,60 (1,8-4,7)		
	35	3,50	-	-	-	3,50 (1,6-3,6)			4,20	-	-	-	4,20 (1,9-5,1)		
	52	5,15	-	-	-	5,15 (1,7-5,8)			6,00	-	-	-	6,00 (2,0-7,8)		
	68	7,10	-	-	-	7,10 (1,8-7,4)			8,50	-	-	-	8,50 (2,0-8,8)		
2 units	22+22	2,20	2,20	-	-	4,40 (2,0-5,1)			2,50	2,50	-	-	5,00 (2,0-6,4)		
	22+27	2,20	2,65	-	-	4,85 (2,0-5,8)			2,50	3,60	-	-	6,10 (2,1-7,5)		
	22+35	2,20	3,50	-	-	5,70 (2,0-6,7)			2,50	4,20	-	-	6,70 (2,3-8,3)		
	22+52	2,14	5,01	-	-	7,15 (2,2-7,7)			2,50	6,00	-	-	8,50 (3,0-9,4)		
	22+68	1,81	5,84	-	-	7,65 (2,3-8,8)			2,01	6,84	-	-	8,85 (3,0-9,8)		
	27+27	2,65	2,65	-	-	5,30 (2,0-6,5)			3,60	3,60	-	-	7,20 (2,4-8,5)		
	27+35	2,54	3,36	-	-	5,90 (2,0-7,4)			3,51	4,09	-	-	7,60 (2,6-8,5)		
	27+52	2,46	4,79	-	-	7,25 (2,3-8,5)			3,24	5,41	-	-	8,65 (3,3-9,4)		
	27+68	2,11	5,64	-	-	7,75 (2,3-8,8)			2,68	6,32	-	-	9,00 (3,3-9,8)		
	35+35	3,40	3,40	-	-	6,80 (2,2-8,4)			4,00	4,00	-	-	8,00 (2,9-8,5)		
	35+52	3,03	4,47	-	-	7,50 (2,6-8,8)			3,60	5,15	-	-	8,75 (3,4-9,8)		
	35+68	2,63	5,33	-	-	7,95 (2,6-8,8)			3,02	6,12	-	-	9,14 (3,4-9,8)		
	52+52	3,95	3,95	-	-	7,90 (2,6-8,8)			4,50	4,50	-	-	9,00 (3,4-9,8)		
	52+68	3,36	4,64	-	-	8,00 (2,7-8,8)			3,89	5,51	-	-	9,40 (3,4-9,8)		
	3 units	22+22+22	2,20	2,20	2,20	-	6,60 (2,0-7,7)			2,50	2,50	2,50	-	7,50 (2,7-9,0)	
22+22+27		2,20	2,20	2,65	-	7,05 (2,0-8,4)			2,47	2,47	3,56	-	8,50 (3,0-9,2)		
22+22+35		2,03	2,03	3,23	-	7,30 (2,4-8,6)			2,34	2,34	3,93	-	8,6 (3,2-9,8)		
22+22+52		1,77	1,77	4,15	-	7,70 (2,7-9,0)			2,01	2,01	4,83	-	8,85 (3,4-9,8)		
22+22+68		1,53	1,53	4,94	-	8,00 (2,9-9,0)			1,71	1,71	5,82	-	9,25 (3,4-9,8)		
22+27+27		2,11	2,54	2,54	-	7,20 (2,3-8,6)			2,23	3,21	3,21	-	8,65 (3,3-9,3)		
22+27+35		1,95	2,35	3,10	-	7,40 (2,6-9,0)			2,12	3,04	3,57	-	8,75 (3,4-9,8)		
22+27+52		1,72	2,07	4,02	-	7,80 (2,9-9,0)			1,86	2,68	4,46	-	9,00 (3,4-9,8)		
22+27+68		1,47	1,77	4,75	-	8,00 (2,9-9,0)			1,61	2,32	5,47	-	9,40 (3,4-9,8)		
22+35+35		1,82	2,89	2,89	-	7,60 (2,7-9,0)			2,03	3,41	3,41	-	8,85 (3,4-9,8)		
22+35+52		1,60	2,55	3,75	-	7,90 (2,9-9,0)			1,79	3,01	4,30	-	9,10 (3,4-9,8)		
22+35+68		1,38	2,19	4,44	-	8,00 (2,9-9,0)			1,55	2,60	5,26	-	9,4 (3,4-9,8)		
22+52+52		1,41	3,30	3,30	-	8,00 (2,9-9,0)			1,62	3,89	3,89	-	9,4 (3,4-9,8)		
22+52+68		1,22	2,85	3,93	-	8,00 (2,9-9,0)			1,38	3,32	4,70	-	9,4 (3,4-9,8)		
27+27+27		2,43	2,43	2,43	-	7,30 (2,5-8,6)			2,95	2,95	2,95	-	8,85 (3,4-9,4)		
27+27+35		2,26	2,26	2,98	-	7,50 (2,7-9,0)			2,81	2,81	3,28	-	8,90 (3,4-9,8)		
27+27+52		2,00	2,00	3,89	-	7,90 (2,9-9,0)			2,51	2,51	4,18	-	9,20 (3,4-9,8)		
27+27+68		1,71	1,71	4,58	-	8,00 (2,9-9,0)			2,16	2,16	5,09	-	9,40 (3,4-9,8)		
27+35+35		2,13	2,81	2,81	-	7,75 (2,7-9,0)			2,70	3,15	3,15	-	9,00 (3,4-9,8)		
27+35+52		1,88	2,48	3,65	-	8,00 (2,9-9,0)			2,43	2,83	4,04	-	9,30 (3,4-9,8)		
27+35+68		1,60	2,11	4,29	-	8,00 (2,9-9,0)			2,08	2,42	4,90	-	9,40 (3,4-9,8)		
27+52+52		1,64	3,18	3,18	-	8,00 (2,9-9,0)			2,17	3,62	3,62	-	9,40 (3,4-9,8)		
35+35+35		2,65	2,65	2,65	-	7,95 (2,9-9,0)			3,03	3,03	3,03	-	9,10 (3,4-9,8)		
35+35+52		2,30	2,30	3,39	-	8,00 (2,9-9,0)			2,73	2,73	3,90	-	9,35 (3,4-9,8)		
35+35+68		1,99	1,99	4,03	-	8,00 (2,9-9,0)			2,34	2,34	4,73	-	9,40 (3,4-9,8)		
35+52+68	2,03	2,99	2,99	-	8,00 (2,9-9,0)			2,44	3,48	3,48	-	9,40 (3,4-9,8)			
4 units	22+22+22+22	1,88	1,88	1,88	1,88	7,50 (2,9-9,2)	1,88 (0,95-2,71)	3,99	2,18	2,18	2,18	2,18	8,70 (3,4-9,8)	1,88 (0,8-2,41)	4,63
	22+22+22+27	1,82	1,82	1,82	2,19	7,65 (2,9-9,2)	1,88 (0,95-2,71)	4,07	1,99	1,99	1,99	2,87	8,85 (3,4-9,8)	1,92 (0,75-2,41)	4,61
	22+22+22+35	1,71	1,71	1,71	2,72	7,85 (2,9-9,2)	1,88 (0,95-2,71)	4,18	1,91	1,91	1,91	3,21	8,95 (3,4-9,8)	1,97 (0,75-2,41)	4,54
	22+22+22+52	1,50	1,50	1,50	3,51	8,00 (2,9-9,2)	1,725 (0,95-2,71)	4,64	1,71	1,71	1,71	4,11	9,25 (3,4-9,8)	2,04 (0,75-2,41)	4,53
	22+22+22+68	1,28	1,28	1,28	4,15	8,00 (2,9-9,2)	1,725 (0,95-2,71)	4,64	1,47	1,47	1,47	4,99	9,40 (3,4-9,8)	2,04 (0,75-2,41)	4,61
	22+22+27+27	1,76	1,76	2,12	2,12	7,75 (2,9-9,2)	1,88 (0,95-2,71)	4,12	1,85	1,85	2,67	2,67	9,05 (3,4-9,8)	2,04 (0,75-2,41)	4,44
	22+22+27+35	1,66	1,66	2,00	2,64	7,95 (2,9-9,2)	1,725 (0,95-2,71)	4,61	1,79	1,79	2,57	3,00	9,15 (3,4-9,8)	2,04 (0,75-2,41)	4,49
	22+22+27+52	1,44	1,44	1,74	3,38	8,00 (2,9-9,2)	1,725 (0,95-2,71)	4,64	1,61	1,61	2,32	3,86	9,40 (3,4-9,8)	2,04 (0,75-2,41)	4,61
	22+22+27+68	1,24	1,24	1,50	4,01	8,00 (2,9-9,2)	1,725 (0,95-2,71)	4,64	1,37	1,37	1,98	4,67	9,40 (3,4-9,8)	2,04 (0,75-2,41)	4,61
	22+22+35+35	1,54	1,54	2,46	2,46	8,00 (2,9-9,2)	1,725 (0,95-2,71)	4,64	1,72	1,72	2,88	2,88	9,20 (3,4-9,8)	2,04 (0,75-2,41)	4,51
	22+22+35+52	1,35	1,35	2,15	3,16	8,00 (2,9-9,2)	1,725 (0,95-2,71)	4,64	1,55	1,55	2,60	3,71	9,40 (3,4-9,8)	2,04 (0,75-2,41)	4,61
	22+22+52+52	1,20	1,20	2,80	2,80	8,00 (2,9-9,2)	1,725 (0,95-2,71)	4,64	1,38	1,38	3,32	3,32	9,40 (3,4-9,8)	2,04 (0,75-2,41)	4,61
	22+27+27+27	1,70	2,05	2,05	2,05	7,85 (2,9-9,2)	1,90 (0,95-2,71)	4,13	1,73	2,49	2,49	2,49	9,20 (3,4-9,8)	2,04 (0,75-2,41)	4,51
	22+27+27+35	1,60	1,93	1,93	2,55	8,00 (2,9-9,2)	1,725 (0,95-2,71)	4,64	1,67	2,41	2,41	2,81	9,30 (3,4-9,8)	2,04 (0,75-2,41)	4,56
	22+27+27+52	1,39	1,68	1,68	3,26	8,00 (2,9-9,2)	1,725 (0,95-2,71)	4,64	1,50	2,16	2,16	3,59	9,40 (3,4-9,8)	2,04 (0,75-2,41)	4,61
	22+27+35+35	1,49	1,79	2,36	2,36	8,00 (2,9-9,2)	1,725 (0,95-2,71)	4,64	1,62	2,33	2,72	2,72	9,40 (3,4-9,8)	2,04 (0,75-2,41)	4,61
	22+27+35+52	1,30	1,57	2,07	3,05	8,00 (2,9-9,2)	1,725 (0,95-2,71)	4,64	1,44	2,08	2,42	3,46	9,40 (3,4-9,8)	2,04 (0,75-2,41)	4,61
	22+35+35+35	1,39	2,20	2,20	2,20	8,00 (2,9-9,2)	1,725 (0,95-2,71)	4,64	1,56	2,61	2,61	2,61	9,40 (3,4-9,8)	2,04 (0,75-2,41)	4,61
	22+35+35+52	1,23	1,95	1,95	2,87	8,00 (2,9-9,2)	1,725 (0,95-2,71)	4,64	1,39	2,34	2,34	3,34	9,40 (3,4-9,8)	2,04 (0,75-2,41)	4,61
	27+27+27+27	2,00	2,00	2,00	2,00	8,00 (2,9-9,2)	1,725 (0,95-2,71)	4,64	2,35	2,35	2,35	2,35	9,40 (3,4-9,8)	2,04 (0,75-2,41)	4,61
	27+27+27+35	1,85	1,85	1,85	2,45	8,00 (2,9-9,2)	1,725 (0,95-2,71)	4,64	2,26	2,26	2,26	2,63	9,40 (3,4-9,8)	2,04 (0,75-2,41)	4,61
	27+27+27+52	1,62	1,62	1,62	3,15	8,00 (2,9-9,2)	1,725 (0,95-2,71)	4,64	2,01	2,01	2,01	3,36	9,40 (3,4-9,8)	2,04 (0,75-2,41)	4,61
	27+27+35+35	1,72	1,72	2,28	2,28	8,00 (2,9-9,2)	1,725 (0,95-2,71)	4,64	2,17	2,17	2,53	2,53	9,40 (3,4-9,8)	2,04 (0,75-2,41)	4,61
	27+27+35+52	1,52	1,52	2,01	2,95	8,00 (2,9-9,2)	1,725 (0,95-2,71)	4,64	1,94	1,94	2,27	3,24	9,40 (3,4-9,8)	2,04 (0,75-2,41)	4,61
	27+35+35+35	1,61	2,13	2,13	2,13	8,00 (2,9-9,2)	1,725 (0,95-2,71)	4,64	2,09	2,44	2,44	2,44	9,40 (3,4-9,8)	2,04 (0,75-2,41)	4,61
35+35+35+35	2,00	2,00	2,00	2,00	8,00 (2,9-9,2)	1,725 (0,95-2,71)	4,64	2,35	2,35	2,35	2,35	9,40 (3,4-9,8)	2,04 (0,75-2,41)	4,61	

Matchable i.u.
 22=AWMI22AHL/F
 27=AWMI27AHL/F
 35=AWMI35AHL/F
 52=AWI52AHL/F
 68=AWI68AHL/F

SPLIT/PACKAGE DCI



AWS 71 PH/H3

- PAM DC Inverter technology
- Automatic change-over between cooling and heating modes
- Special function during heat pump start-up and defrosting cycle to avoid cool air emission in the room
- Among controls available for this kind of indoor unit (all optional): the infrared remote control, equipped with a 24h digital timer and a temperature sensor granting automatically the best comfort conditions ("I Feel" feature); a special wired controller with configuration, diagnostic and weekly timer capabilities
- Night set back capability
- Dry function
- New three-speed tangential fan by remote control, granting a better and low noise air diffusion
- Horizontal flap swinging or to be set to a fixed position by remote control
- Vertical flap by manual control
- Washable air filters
- Dynamic refrigerant control by DC Inverter compressor and circuit, electronic valve and fuzzy logic managed by a powerful microprocessor
- Auto restart after a power supply black out
- Electronic protection against over-pressures
- Wide operating range with outdoor air temperatures up to -15°C in both cooling and heating modes
- Single-phase (230/1/50) and Three-phase (400/3/50) power supply
- High efficiency Twin rotary compressor

PRODUCT NAME		AWS71PH/H3/H3B	
Indoor unit		AWS71PH	
Outdoor unit		AES71PIH/H3/H3B	
Features	Units	Cooling	Heating
Cooling/Heating capacity - nominal (min-max)	kW	7,10 [2,2-8,0]	8,00 [2,2-9,0]
	BTU/h	24.000	27.000
	kcal/h	6.100	6.880
Energy label class	ABCDEFG	B	B
E.E.R. / C.O.P.	[kW/kW]	3,01	3,54
Air flowrate Indoor (h.m.l.)	m³/h	1.140-1.020-840	
Dehumidification	l/h	4,0	
Fan speeds (Indoor / Outdoor)	n°	3 + Auto / 3 (Auto)	
Sound pressure Indoor (h.m.l.)	dB(A)	41-37-34	
Sound pressure Outdoor (h.)	dB(A)	49	
Power supply	V/Ph/Hz	230/1/50-400/3/50	
Running consumption	kW	2,36	2,26
Annual energy cons.- cooling mode (500h) - Directive 2002/31/CE	kWh	1.180	-
Compressor type		DCInverter Twin Rotary	
Refrigerant type		R410A	
Liquid pipe diameter	mm[inch"]	9,52[3/8"]	
Gas pipe diameter	mm[inch"]	15,88[5/8"]	
Max. pipe lenght with gas standard charge	m	30	
Max. pipe lenght with gas additional charge	m	50	
Gas additional charge	gr/m	40	
Max. height between units (Outdoor on top)	m	50	
Max. height between units (Indoor on top)	m	30	
Net weight Indoor / Outdoor	Kg	21/58	
Net dimension Indoor (H./W./D.)	mm	330x1.140x228	
Net dimension Outdoor (H./W./D.)	mm	780x940x340	

The technical data here indicated are in compliance with the European standard EN14511 - Directive 2002/31/EC

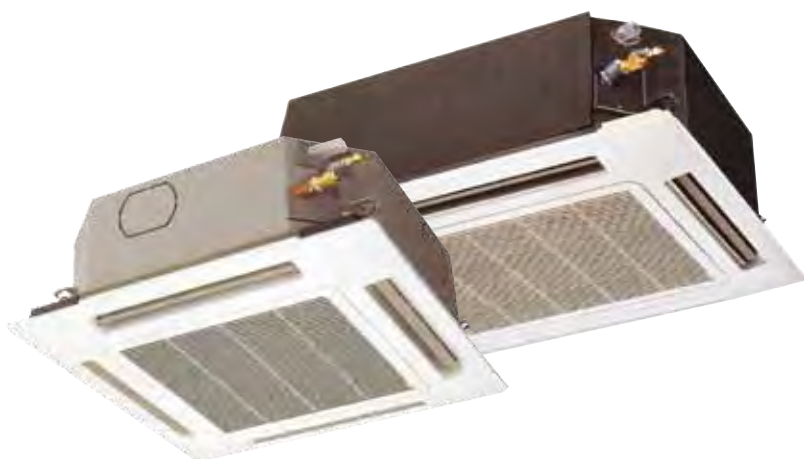

ASS 71/100 PH/H3

- PAM DC Inverter technology
- Automatic change-over between cooling and heating modes
- Special function during heat pump start-up and defrosting cycle to avoid cool air emission in the room
- Among controls available for this kind of indoor unit (all optional): the infrared remote control, equipped with a 24h digital timer and a temperature sensor granting automatically the best comfort conditions ("I Feel" feature); a special wired controller with configuration, diagnostic and weekly timer capabilities
- Night set back capability
- Dry function
- New three-speed centrifugal fan by remote control, granting a better and low noise air diffusion
- Special system to avoid condensate dripping from air outlet ribs
- Four horizontal flaps swinging or to be set on a fixed position by remote control
- Washable filters
- Integrated pump for condensate discharge
- Dynamic refrigerant control by DC Inverter compressor and circuit, electronic
- Valve and fuzzy logic managed by a powerful microprocessor
- Auto restart after a power supply black out
- Electronic protection against over-pressures
- Wide operating range with outdoor air temperatures up to -15°C in both cooling and heating modes
- Single-phase (230/1/50) and three-phase (400/3/50) power supply
- High efficiency Twin rotary compressor

PRODUCT NAME		ASS71PH/H3/H3B		ASS100PH/H3/H3B		
Indoor unit		ASS71PH		ASS100PH		
Outdoor unit [1ph/3ph]		AES71PIH/H3/H3B		AES100PIH/H3/H3B		
Features		Units	Cooling	Heating	Cooling	Heating
Cooling/Heating capacity - nominal (min-max)		kW	7,10 [2,2-8,0]	8,00 [2,2-9,0]	10,00 [2,2-11,2]	11,20 [2,2-12,50]
		BTU/h	24.000	27.000	34.000	38.000
		kcal/h	6.100	6.880	8.600	9.630
Energy label class		ABCDEFG	A	A	A	A
E.E.R. / C.O.P.		[kW/kW]	3,33	3,86	3,21	3,78
Air flowrate Indoor [h.m.l.]		m³/h	1.140-1.020-840		1.920-1.680-1.320	
Dehumidification		l/h	3,6		4,6	
Fan speeds [Indoor / Outdoor]		n°	3 + Auto / variable		3 + Auto / variable	
Sound pressure Indoor [h.m.l.]		dB(A)	47-45-41		53-50-46	
Sound pressure Outdoor [h.]		dB(A)	47	49	51	52
Power supply [1ph-3ph]		V/Ph/Hz	230/1/50 - 400/3/50		230/1/50 - 400/3/50	
Running consumption		kW	2,13	2,07	3,12	2,96
Annual energy cons. - cooling mode (500h) - Directive 2002/31/CE		kWh	1.065	-	1.560	-
Compressor type			DCInverter Twin Rotary		DCInverter Twin Rotary	
Refrigerant type			R410A		R410A	
Liquid pipe diameter		mm[inch"]	9,52[3/8"]		9,52[3/8"]	
Gas pipe diameter		mm[inch"]	15,88[5/8"]		15,88[5/8"]	
Max. pipe lenght with gas standard charge		m	30		30	
Max. pipe lenght with gas additional charge		m	50		50	
Max. height between units [Outdoor on top]		m	30		30	
Max. height between units [Indoor on top]		m	15		15	
Net weight Indoor / Outdoor		Kg	28/58		35/65	
Net dimension Indoor [H./W./D.]		mm	338x860x860		338x1.150x860	
Net dimension Outdoor [H./W./D.]		mm	780x940x340		780x940x340	

The technical data here indicated are in compliance with the European standard EN14511 - Directive 2002/31/EC

PACKAGE DC INVERTER

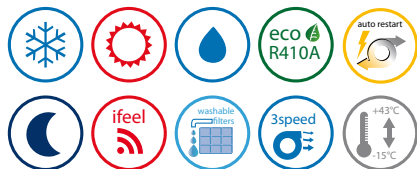

ASS 125 PH/H3

- PAM DC Inverter technology
- Automatic change-over between cooling and heating modes
- Special function during heat pump start-up and defrosting cycle to avoid cool air emission in the room
- Among controls available for this kind of indoor unit (all optional): the infrared remote control, equipped with a 24h digital timer and a temperature sensor granting automatically the best comfort conditions ("I Feel" feature); a special wired controller with configuration, diagnostic and weekly timer capabilities
- Night set back capability
- Dry function
- New three-speed centrifugal fan by remote control, granting a better and low noise air diffusion
- Special system to avoid condensate dripping from air outlet ribs
- Four horizontal flaps swinging or to be set on a fixed position by remote control
- Washable filters
- Integrated pump for condensate discharge
- Dynamic refrigerant control by DC Inverter compressor and circuit, electronic
- Valve and fuzzy logic managed by a powerful microprocessor
- Auto restart after a power supply black out
- Electronic protection against over-pressures
- Wide operating range with outdoor air temperatures up to -15°C in both cooling and heating modes
- Single-phase (230/1/50) and three-phase (400/3/50) power supply
- High efficiency Twin rotary compressor

PRODUCT NAME		ASS125PH/H3/H3B	
Indoor unit		ASS125PH	
Outdoor unit (1ph/3ph)		AES125PIH/H3/H3B	
Features	Units	Cooling	Heating
Cooling/Heating capacity - nominal (min-max)	kW	12,50 [2,7-14,0]	14,00 [2,7-16,00]
	BTU/h	42.500	48.000
	kcal/h	10.750	12.040
Energy label class	ABCDEF	A	A
E.E.R. / C.O.P.	(kW/kW)	3,24	3,66
Air flowrate Indoor (h.m.l.)	m³/h	1.920-1.680-1.320	
Dehumidification	l/h	6,3	
Fan speeds (Indoor / Outdoor)	n°	3 + Auto / variable	
Sound pressure Indoor (h.m.l.)	dB(A)	53-50-46	
Sound pressure Outdoor (h.)	dB(A)	52	53
Power supply (1ph-3ph)	V/Ph/Hz	230/1/50 - 400/3/50	
Running consumption	kW	3,86	3,83
Annual energy cons.- cooling mode (500h) - Directive 2002/31/CE	kWh	1.930	-
Compressor type		DCInverter Twin Rotary	
Refrigerant type		R410A	
Liquid pipe diameter	mm(inch")	9,52(3/8")	
Gas pipe diameter	mm(inch")	15,88(5/8")	
Max. pipe lenght with gas standard charge	m	30	
Max. pipe lenght with gas additional charge	m	50	
Max. height between units (Outdoor on top)	m	30	
Max. height between units (Indoor on top)	m	15	
Net weight Indoor / Outdoor	Kg	35/100	
Net dimension Indoor (H./W./D.)	mm	338x1.150x860	
Net dimension Outdoor (H./W./D.)	mm	1.230x940x340	

The technical data here indicated are in compliance with the European standard EN14511 - Directive 2002/31/EC

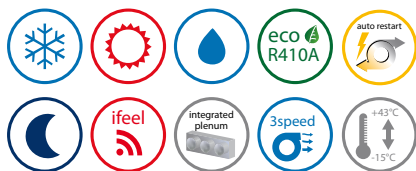

ADS 71 PH/H3

- PAM DC Inverter technology
- Three-way duct connection
- Automatic change-over between cooling and heating modes
- Special function during heat pump start-up and defrosting cycle to avoid cool air emission in the room
- Among controls available for this kind of indoor unit (all optional): the infrared remote control, equipped with a 24h digital timer and a temperature sensor granting automatically the best comfort conditions ("I Feel" feature); a special wired controller with configuration, diagnostic and weekly timer capabilities
- Night set back capability
- Dry function
- Possibility to increase the Static Pressure
- New centrifugal fan, with double static pressure, three speeds by remote control, granting a better and low noise air diffusion
- Integrated pump for condensate discharge
- Dynamic refrigerant control by DC Inverter compressor and circuit, electronic valve and fuzzy logic managed by a powerful micro-processor
- Auto restart after a power supply black out
- Electronic protection against over-pressures
- Wide operating range with outdoor air temperatures up to -15°C in both cooling and heating modes
- Single (230/1/50) and three-phase (400/3/50) power supply
- High efficiency Twin rotary compressor

PRODUCT NAME		ADS71PH/H3/H3B	
Indoor unit		ADS71PH	
Outdoor unit (1ph/3ph)		AES71PIH/H3/H3B	
Features	Units	Cooling	Heating
Cooling/Heating capacity - nominal (min-max)	kW	7,10 (2,2-8,0)	8,00 (2,2-9,0)
	BTU/h	24.000	27.000
	kcal/h	6.100	6.880
Energy label class	ABCDEFG	C	C
E.E.R. / C.O.P.	(kW/kW)	2,83	3,35
Air flowrate (h.m.l.)	m³/h	1.080-900-780	
Dehumidification	l/h	3,5	
External static pressure (min-max)	mm W.C.	5-10	
Fan speeds (Indoor / Outdoor)	n°	3 + Auto / variable	
Sound power Indoor (h.m.l.)	dB(A)	43-39-36	
Sound pressure Indoor (h.m.l.)	dB(A)	34-30-27	
Sound pressure Indoor at ducts exit	dB(A)	< 20	
Sound pressure Outdoor (h.)	dB(A)	47	49
Power supply (1ph-3ph)	V/Ph/Hz	230/1/50 - 400/3/50	
Running consumption - nominal (min-max)	kW	2,51	2,39
Annual energy cons.- cooling mode (500h) - Directive 2002/31/CE	kWh	1.255	-
Compressor type		DCInverter Twin Rotary	
Refrigerant type		R410A	
Liquid pipe diameter	mm(inch")	9,52(3/8")	
Gas pipe diameter	mm(inch")	15,88(5/8")	
Max. pipe lenght with gas standard charge	m	30	
Max. pipe lenght with gas additional charge	m	50	
Max. height between units (Outdoor on top)	m	30	
Max. height between units (Indoor on top)	m	15	
Ducts diameter	mm	200	
Net weight Indoor / Outdoor	Kg	32/58	
Net dimension Indoor (H./W./D.)	mm	310x1.000x630	
Net dimension Outdoor (H./W./D.)	mm	780x940x340	

The technical data here indicated are in compliance with the European standard EN14511 - Directive 2002/31/EC

PACKAGE DC INVERTER



ADS 100 PH/H3

- PAM DC Inverter technology
- Four-way duct connection
- Automatic change-over between cooling and heating modes
- Special function during heat pump start-up and defrosting cycle to avoid cool air emission in the room
- Among controls available for this kind of indoor unit (all optional): the infrared remote control, equipped with a 24h digital timer and a temperature sensor granting automatically the best comfort conditions ("I Feel" feature); a special wired controller with configuration, diagnostic and weekly timer capabilities
- Night set back capability
- Dry function
- Possibility to increase the Static Pressure
- Integrated pump for condensate discharge
- New centrifugal fan, with double static pressure, three speeds by remote control, granting a better and low noise air diffusion
- Dynamic refrigerant control by DC Inverter compressor and circuit, electronic valve and fuzzy logic managed by a powerful micro-processor
- Auto restart after a power supply black out
- Electronic protection against over-pressures
- Wide operating range with outdoor air temperatures up to -15°C in both cooling and heating modes
- Single (230/1/50) and three-phase (400/3/50) power supply
- High efficiency Twin rotary compressor

PRODUCT NAME		ADS100PH/H3/H3B	
Indoor unit		ADS100PH	
Outdoor unit (1ph/3ph)		AES100PIH/H3/H3B	
Features	Units	Cooling	Heating
Cooling/Heating capacity - nominal (min-max)	kW	10,00 [2,2-11,2]	11,20 [2,2-12,50]
	BTU/h	34.000	38.000
	kcal/h	8.600	9.630
Energy label class	ABCDEF G	C	C
E.E.R. / C.O.P.	(kW/kW)	2,82	3,39
Air flowrate (h.m.l.)	m ³ /h	1.800-1.560-1.260	
Dehumidification	l/h	4,2	
External static pressure (min-max)	mm W.C.	5-10	
Fan speeds (Indoor / Outdoor)	n°	3 + Auto / variable	
Sound power Indoor (h.m.l.)	dB(A)	47-42-40	
Sound pressure Indoor (h.m.l.)	dB(A)	38-33-31	
Sound pressure Indoor at ducts exit	dB(A)	< 20	
Sound pressure Outdoor (h.)	dB(A)	51	52
Power supply (1ph-3ph)	V/Ph/Hz	230/1/50	
Running consumption - nominal (min-max)	kW	3,55	3,30
Annual energy cons. - cooling mode (500h) - Directive 2002/31/CE	kWh	1,775	-
Compressor type		DCInverter Twin Rotary	
Refrigerant type		R410A	
Liquid pipe diameter	mm(inch")	9,52(3/8")	
Gas pipe diameter	mm(inch")	15,88(5/8")	
Max. pipe lenght with gas standard charge	m	30	
Max. pipe lenght with gas additional charge	m	50	
Max. height between units (Outdoor on top)	m	30	
Max. height between units (Indoor on top)	m	15	
Ducts diameter	mm	200	
Net weight Indoor / Outdoor	Kg	47/65	
Net dimension Indoor (H./W./D.)	mm	310x1.480x630	
Net dimension Outdoor (H./W./D.)	mm	780x940x340	

The technical data here indicated are in compliance with the European standard EN14511 - Directive 2002/31/EC

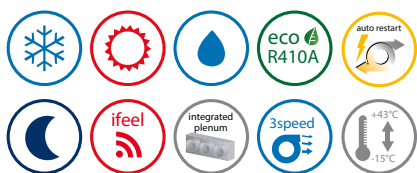

ADS 125 PH/H3

- PAM DC Inverter technology
- Four-way duct connection
- Automatic change-over between cooling and heating modes
- Special function during heat pump start-up and defrosting cycle to avoid cool air emission in the room
- Among controls available for this kind of indoor unit (all optional): the infrared remote control, equipped with a 24h digital timer and a temperature sensor granting automatically the best comfort conditions ("I Feel" feature); a special wired controller with configuration, diagnostic and weekly timer capabilities
- Night set back capability
- Dry function
- Possibility to increase the Static Pressure

- Integrated pump for condensate discharge
- New centrifugal fan, with double static pressure, three speeds by remote control, granting a better and low noise air diffusion
- Dynamic refrigerant control by DC Inverter compressor and circuit, electronic valve and fuzzy logic managed by a powerful micro-processor
- Auto restart after a power supply black out
- Electronic protection against over-pressures
- Wide operating range with outdoor air temperatures up to -15°C in both cooling and heating modes
- Single (230/1/50) and three-phase (400/3/50) power supply
- High efficiency Twin rotary compressor

PRODUCT NAME		ADS125PH/H3/H3B	
Indoor unit		ADS125PH	
Outdoor unit (1ph/3ph)		AES125PIH/H3/H3B	
Features	Units	Cooling	Heating
Cooling/Heating capacity - nominal (min-max)	kW	12,50 (2,7-14,0)	14,00 (2,7-16,00)
	BTU/h	42.500	48.000
	kcal/h	10.750	12.040
Energy label class	ABCDEFG	C	C
E.E.R. / C.O.P.	(kW/kW)	2,87	3,26
Air flowrate (h.m.l.)	m ³ /h	1.980-1.560-1.320	
Dehumidification	l/h	6,6	
External static pressure (min-max)	mm W.C.	5-10	
Fan speeds (Indoor / Outdoor)	n°	3 + Auto / variable	
Sound power Indoor (h.m.l.)	dB(A)	49-46-42	
Sound pressure Indoor (h.m.l.)	dB(A)	40-37-33	
Sound pressure Indoor at ducts exit	dB(A)	< 20	
Sound pressure Outdoor (h.)	dB(A)	52	53
Power supply (1ph-3ph)	V/Ph/Hz	230/1/50 - 400/3/50	
Running consumption - nominal (min-max)	kW	4,36	4,29
Annual energy cons.- cooling mode (500h) - Directive 2002/31/CE	kWh	2.180	-
Compressor type		DCInverter Twin Rotary	
Refrigerant type		R410A	
Liquid pipe diameter	mm(inch")	9,52(3/8")	
Gas pipe diameter	mm(inch")	15,88(5/8")	
Max. pipe lenght with gas standard charge	m	30	
Max. pipe lenght with gas additional charge	m	50	
Max. height between units (Outdoor on top)	m	30	
Max. height between units (Indoor on top)	m	15	
Ducts diameter	mm	200	
Net weight Indoor / Outdoor	Kg	47/100	
Net dimension Indoor (H./W./D.)	mm	310x1.480x630	
Net dimension Outdoor (H./W./D.)	mm	1.230x940x340	

The technical data here indicated are in compliance with the European standard EN14511 - Directive 2002/31/EC

PACKAGE DC INVERTER

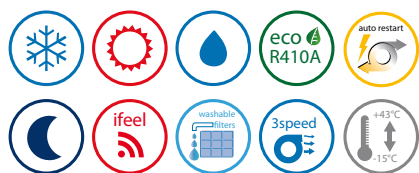

ACS 71/100 PH/H3

- PAM DC Inverter technology
- Automatic change-over between cooling and heating modes
- Special function during heat pump start-up and defrosting cycle to avoid cool air emission in the room
- Among controls available for this kind of indoor unit (all optional): the infrared remote control, equipped with a 24h digital timer and a temperature sensor granting automatically the best comfort conditions ("I Feel" feature); a special wired controller with configuration, diagnostic and weekly timer capabilities
- Night set back capability
- Dry function
- Three-speed centrifugal fan by remote control, granting a better and low noise air diffusion
- Horizontal flap swinging or to be set on a fixed position by remote control, with automatic positioning according to selected mode (cooling or heating)
- Washable air filters
- Dynamic refrigerant control by DC Inverter compressor and circuit, electronic valve and fuzzy logic managed by a powerful microprocessor
- Auto restart after a power supply black out
- Electronic protection against over-pressures
- Wide operating range with outdoor air temperatures up to -15°C in both cooling and heating modes
- Single-phase (230/1/50) and three-phase (400/3/50) power supply
- High efficiency Twin rotary compressor

PRODUCT NAME	ACS71PH/H3/H3B		ACS100PH/H3/H3B		
	ACS71PH	AES71PIH/H3/H3B	ACS100PH	AES100PIH/H3/H3B	
Indoor unit	ACS71PH		ACS100PH		
Outdoor unit (1ph/3ph)	AES71PIH/H3/H3B		AES100PIH/H3/H3B		
Features	Units	Cooling	Heating	Cooling	Heating
Cooling/Heating capacity - nominal (min-max)	kW	7,10 [2,2-8,0]	8,00 [2,2-9,0]	10,00 [2,2-11,2]	11,20 [2,2-12,50]
	BTU/h	24.000	27.000	34.000	38.000
	kcal/h	6.100	6.880	8.600	9.630
Energy label class	ABCDEFGF	B	B	B	A
E.E.R. / C.O.P.	[kW/kW]	3,02	3,56	3,04	3,67
Air flowrate Indoor [h.m.l.]	m³/h	1.098-900-840		1.650-1.380-1.200	
Dehumidification	l/h	3,0		3,9	
Fan speeds (Indoor / Outdoor)	n°	3 + Auto / variable		3 + Auto / variable	
Sound pressure Indoor [h.m.l.]	dB(A)	38-36-33		41-38-35	
Sound pressure Outdoor [h.]	dB(A)	47	49	51	52
Power supply (1ph-3ph)	V/Ph/Hz	230/1/50 - 400/3/50		230/1/50 - 400/3/50	
Running consumption	kW	2,35	2,25	3,29	3,67
Annual energy cons.- cooling mode (500h) - Directive 2002/31/CE	kWh	1.175	-	1.645	-
Compressor type		DCInverter Twin Rotary		DCInverter Twin Rotary	
Refrigerant type		R410A		R410A	
Liquid pipe diameter	mm[inch"]	9,52[3/8"]		9,52[3/8"]	
Gas pipe diameter	mm[inch"]	15,88[5/8"]		15,88[5/8"]	
Max. pipe lenght with gas standard charge	m	30		30	
Max. pipe lenght with gas additional charge	m	50		50	
Max. height between units (Outdoor on top)	m	30		30	
Max. height between units (Indoor on top)	m	15		15	
Net weight Indoor / Outdoor	Kg	25/58		33/65	
Net dimension Indoor [H./W./D.]	mm	210x1.180x680		210x1.595x680	
Net dimension Outdoor [H./W./D.]	mm	780x940x340		780x940x340	

The technical data here indicated are in compliance with the European standard EN14511 - Directive 2002/31/CE

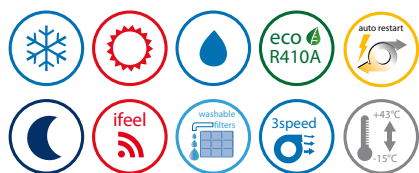

ACS 125 PH/H3

- PAM DC Inverter technology
 - Automatic change-over between cooling and heating modes
- Special function during heat pump start-up and defrosting cycle to avoid cool air emission in the room
- Among controls available for this kind of indoor unit (all optional): the infrared remote control, equipped with a 24h digital timer and a temperature sensor granting automatically the best comfort conditions ("I Feel" feature); a special wired controller with configuration, diagnostic and weekly timer capabilities
 - Night set back capability
 - Dry function
 - Three-speed centrifugal fan by remote control, granting a better and low noise air diffusion
 - Horizontal flap swinging or to be set on a fixed position by remote control, with automatic positioning according to selected mode (cooling or heating)

- Washable air filters
- Dynamic refrigerant control by DC Inverter compressor and circuit, electronic valve and fuzzy logic managed by a powerful microprocessor
- Auto restart after a power supply black out
- Electronic protection against over-pressures
- Wide operating range with outdoor air temperatures up to -15°C in both cooling and heating modes
- Single-phase (230/1/50) and three-phase (400/3/50) power supply
- High efficiency Twin rotary compressor

PRODUCT NAME		ACS125PH/H3/H3B	
Indoor unit		ACS125PH	
Outdoor unit (1ph/3ph)		AES125PIH/H3/H3B	
Features	Units	Cooling	Heating
Cooling/Heating capacity - nominal (min-max)	kW	12,50 [2,7-14,0]	14,00 [2,7-16,00]
	BTU/h	42.500	48.000
	kcal/h	10.750	12.040
Energy label class	ABCDEFGF	B	B
E.E.R. / C.O.P.	(kW/kW)	3,03	3,44
Air flowrate Indoor (h.m.l.)	m³/h	1.800-1.560-1.320	
Dehumidification	l/h	5,6	
Fan speeds (Indoor / Outdoor)	n°	3 + Auto / variable	
Sound pressure Indoor (h.m.l.)	dB(A)	43-40-37	
Sound pressure Outdoor (h.)	dB(A)	52	53
Power supply (1ph-3ph)	V/Ph/Hz	230/1/50 - 400/3/50	
Running consumption	kW	4,12	4,07
Annual energy cons.- cooling mode (500h) - Directive 2002/31/CE	kWh	2,060	-
Compressor type		DCInverter Twin Rotary	
Refrigerant type		R410A	
Liquid pipe diameter	mm(inch")	9,52(3/8")	
Gas pipe diameter	mm(inch")	15,88(5/8")	
Max. pipe lenght with gas standard charge	m	30	
Max. pipe lenght with gas additional charge	m	50	
Max. height between units (Outdoor on top)	m	30	
Max. height between units (Indoor on top)	m	15	
Net weight Indoor / Outdoor	Kg	35/100	
Net dimension Indoor (H./W./D.)	mm	210x1.595x680	
Net dimension Outdoor (H./W./D.)	mm	1.230x940x340	

The technical data here indicated are in compliance with the European standard EN14511 - Directive 2002/31/EC

Multipackage DC Inverter

AES 125 PIH/H3

Cooling: 12,5 kW
Heating: 14 kW



AES 125 PIH3B

Cooling: 12,5 kW
Heating: 14 kW

AES 71 PIH/H3(B)

Cooling: 7,1 kW
Heating: 8 kW

AES 100 PIH/H3(B)

Cooling:10 kW
Heating: 11,2 kW

OUTDOOR/INDOOR UNITS MATCHING

OUTDOOR UNIT MODEL				AES71PIH/H3/H3B									
Indoor unit models		Type	Cooling					Heating					
			Indoor capacity (kW)				Total capacity kW	Indoor capacity (kW)				Total capacity kW	
			A	B	C	D		A	B	C	D		
Connectable Indoor units	1 unit	AWS71PH	High-wall	7,10	-	-	-	7,1 (2,2-8,0)	8,00	-	-	-	8,0 (2,2-9,0)
		ASS71PH	Cassette	7,10	-	-	-	7,1 (2,2-8,0)	8,00	-	-	-	8,0 (2,2-9,0)
		ACS71PH	Underceiling	7,10	-	-	-	7,1 (2,2-8,0)	8,00	-	-	-	8,0 (2,2-9,0)
	2 units also mixed	ADS71PH	Ducted	7,10	-	-	-	7,1 (2,2-8,0)	8,00	-	-	-	8,0 (2,2-9,0)
		AWS36PH	High-wall	3,55	3,55	-	-	7,1 (2,2-8,0)	4,00	4,00	-	-	8,0 (2,2-9,0)
		ASS36PH	Cassette	3,55	3,55	-	-	7,1 (2,2-8,0)	4,00	4,00	-	-	8,0 (2,2-9,0)
		ADS36PH	Ducted	3,55	3,55	-	-	7,1 (2,2-8,0)	4,00	4,00	-	-	8,0 (2,2-9,0)
		FC36PHG	Floor/Ceiling	3,55	3,55	-	-	7,1 (2,2-8,0)	4,00	4,00	-	-	8,0 (2,2-9,0)

OUTDOOR UNIT MODEL				AES100PIH/H3/H3B									
Indoor unit models		Type	Cooling					Heating					
			Indoor capacity (kW)				Total capacity kW	Indoor capacity (kW)				Total capacity kW	
			A	B	C	D		A	B	C	D		
Connectable Indoor units	1 unit	ASS100PH	Cassette	10,00	-	-	-	10,0 (2,2-11,2)	11,20	-	-	-	11,2 (2,2-12,5)
		ACS100PH	Underceiling	10,00	-	-	-	10,0 (2,2-11,2)	11,20	-	-	-	11,2 (2,2-12,5)
		ADS100PH	Ducted	10,00	-	-	-	10,0 (2,2-11,2)	11,20	-	-	-	11,2 (2,2-12,5)
	2 units also mixed	AWS56PH	High-wall	5,00	5,00	-	-	10,0 (2,2-11,2)	5,60	5,60	-	-	11,2 (2,2-12,5)
		ASS56PH	Cassette	5,00	5,00	-	-	10,0 (2,2-11,2)	5,60	5,60	-	-	11,2 (2,2-12,5)
		ADS56PH	Ducted	5,00	5,00	-	-	10,0 (2,2-11,2)	5,60	5,60	-	-	11,2 (2,2-12,5)
		FC56PHG	Floor/Ceiling	5,00	5,00	-	-	10,0 (2,2-11,2)	5,60	5,60	-	-	11,2 (2,2-12,5)
	3 units also mixed	AWS36PH	High-wall	3,55	3,55	3,55	-	10,65	4,00	4,00	4,00	-	12,0
		ASS36PH	Cassette	3,55	3,55	3,55	-	10,65	4,00	4,00	4,00	-	12,0
		ADS36PH	Ducted	3,55	3,55	3,55	-	10,65	4,00	4,00	4,00	-	12,0
		FC36PHG	Floor/Ceiling	3,55	3,55	3,55	-	10,65	4,00	4,00	4,00	-	12,0

OUTDOOR UNIT MODEL				AES125PIH/H3/H3B									
Indoor unit models		Type	Cooling					Heating					
			Indoor capacity (kW)				Total capacity kW	Indoor capacity (kW)				Total capacity kW	
			A	B	C	D		A	B	C	D		
Connectable Indoor units	1 unit	ASS125PH	Cassette	12,50	-	-	-	12,5 (2,7-14,0)	14,00	-	-	-	14,0 (2,7-16,0)
		ACS125PH	Underceiling	12,50	-	-	-	12,5 (2,7-14,0)	14,00	-	-	-	14,0 (2,7-16,0)
		ADS125PH	Ducted	12,50	-	-	-	12,5 (2,7-14,0)	14,00	-	-	-	14,0 (2,7-16,0)
	2 units also mixed	AWS71PH	High-wall	6,25	6,25	-	-	12,5 (2,7-14,0)	7,00	7,00	-	-	14,0 (2,7-16,0)
		ASS71PH	Cassette	6,25	6,25	-	-	12,5 (2,7-14,0)	7,00	7,00	-	-	14,0 (2,7-16,0)
		ACS71PH	Underceiling	6,25	6,25	-	-	12,5 (2,7-14,0)	7,00	7,00	-	-	14,0 (2,7-16,0)
		ADS71PH	Ducted	6,25	6,25	-	-	12,5 (2,7-14,0)	7,00	7,00	-	-	14,0 (2,7-16,0)
	3 units	AWS45PH	High-wall	4,16	4,16	4,16	-	12,5 (2,7-14,0)	4,66	4,66	4,66	-	14,0 (2,7-16,0)
		ASS45PH	Cassette	4,16	4,16	4,16	-	12,5 (2,7-14,0)	4,66	4,66	4,66	-	14,0 (2,7-16,0)
		ADS45PH	Ducted	4,16	4,16	4,16	-	12,5 (2,7-14,0)	4,66	4,66	4,66	-	14,0 (2,7-16,0)
		FC45PHG	Floor/Ceiling	4,16	4,16	4,16	-	12,5 (2,7-14,0)	4,66	4,66	4,66	-	14,0 (2,7-16,0)
	4 units also mixed	AWS36PH	High-wall	3,12	3,12	3,12	3,12	12,5 (2,7-14,0)	3,50	3,50	3,50	3,50	14,0 (2,7-16,0)
		ASS36PH	Cassette	3,12	3,12	3,12	3,12	12,5 (2,7-14,0)	3,50	3,50	3,50	3,50	14,0 (2,7-16,0)
		ADS36PH	Ducted	3,12	3,12	3,12	3,12	12,5 (2,7-14,0)	3,50	3,50	3,50	3,50	14,0 (2,7-16,0)
		FC36PHG	Floor/Ceiling	3,12	3,12	3,12	3,12	12,5 (2,7-14,0)	3,50	3,50	3,50	3,50	14,0 (2,7-16,0)

Note n.1 Indoor units names contain one number identifying their nominal capacity in kW (i.e.: 71=7,1kW=25000 BTU/h)

Note n.2 The Indoor units here indicated have the same characteristics as the Indoor units used with the MultiSet DCInverter systems described in the following pages; the only difference is the type of pcb installed.

Note n.3 The control systems (wireless, wired, weekly timer, system controller, etc...) are equal to those used for the MultiSet DCInverter systems described in the following pages.

Multipackage DCI features

- Straight cooling and heat pump Package DC Inverter R410A can be set with two, three or four indoor units operating simultaneously; this type of installation is the best for big shops, open space offices, restaurants,...
- The installation of more indoor units in one only big room allows a better diffusion of the conditioned air
- The MultiPackage DC Inverter R410A control systems allow a sophisticated control of single and multi-package configurations by zones, with a maximum of 256 indoor units being managed by one only intelligent controller
- In addition to single-Package DC Inverter R410A features, change-over functionality and Cluster control, both in cooling and heating modes
- Two-unit matchings (duo) are realized with a 2-way distribution joint kit
- Three-unit matchings (trio) are realized with a 3-way distribution joint kit
- Four-unit matchings (quartet) are realized with 3 distribution joint kits (2-way), in tree configuration (1 > 2 > 4)
- Special function during heat pump start-up and defrosting cycle to avoid cool air emission in the room
- "I Feel" feature, granting the best comfort conditions
- Night set back capability
- All MultiPackage DC Inverter R410A systems may be controlled by infrared remote control with digital 24h timer and temperature sensor inside or by a special wired controller with configuration, diagnostic and weekly timer capabilities; in the following pages are shown all the MultiPackage DC Inverter R410A control systems
- Dynamic refrigerant control by DC Inverter compressor and circuit, electronic valve and fuzzy logic managed by a powerful microprocessor
- Auto restart after a power supply black out
- Electronic protection against over-pressures
- Wide operating range with outdoor air temperatures up to -15°C in both cooling and heating modes
- Single-phase (230/1/50) and Three-phase (400/3/50) power supply thanks to DC Inverter technology low consumption
- Double rotary compressor



HIGH WALL INDOOR UNITS



CASSETTE INDOOR UNITS



DUCTED INDOOR UNITS



CEILING INDOOR UNITS



FLOOR/CEILING INDOOR UNITS

Pipe lines

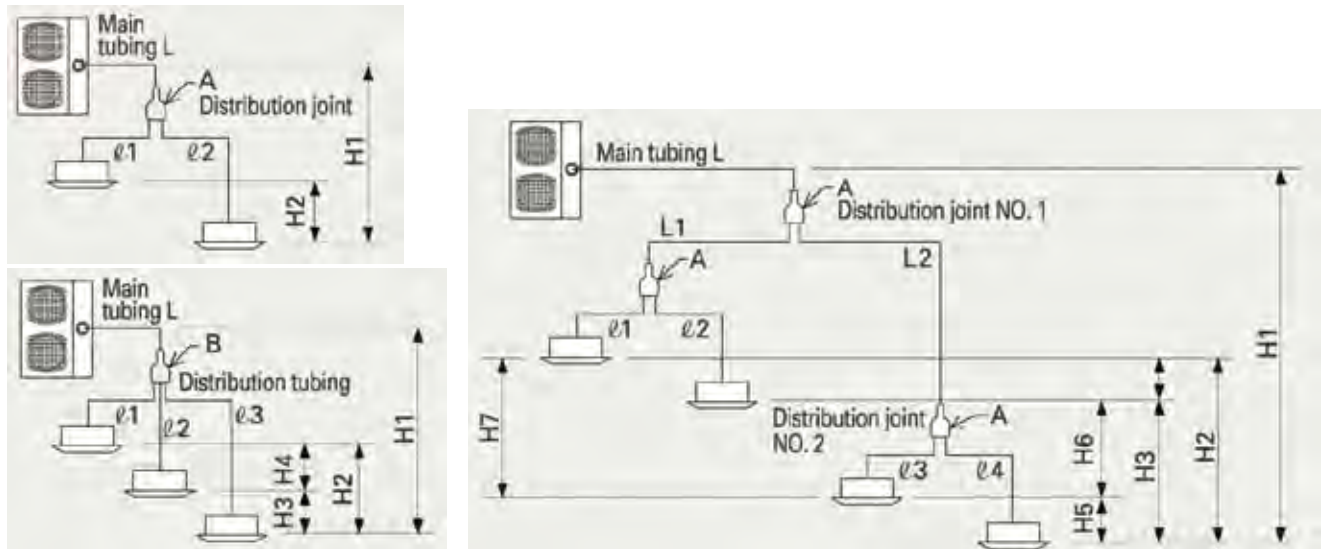

PIPES LENGTH AND DIFFERENCES BETWEEN UNITS IN DUO, TRIO AND QUARTET CONFIGURATIONS

Description	Duo	Trio	Quartet	Length (m)
	L+l1	L+l1, L+l2	L+L1+l1, L+L1+l2	50
Tubing length from the Outdoor unit to the farthest Indoor unit	L+l2	L+l3	L+L2+l3, L+L2+l4	
Tubing length after the first distribution	l1, l2	l1, l2, l3	L1+l1, L1+l2 L2+l3, L2+l4	15
Difference between maximum and minimum tubing length, after the first distribution	l1>l2	l1>l2>l3	Max: L2+l4	10
	l1-l2	l1-l2 l1-l3 l2-l3	Min: L1+l1 (L2+l4)-(L1+l1)	
Max. tubing length difference at distribution joint no. 1	-	-	L2>L1 L2-L1	10
Max. tubing length difference at distribution joint no. 2	-	-	l2>l1 l4>l3 l2-l1 l4-l3	10
Max. height difference between units (Outdoor on top)	H1			30
Max. height difference between units (Indoor on top)	H1			15
Max. height difference between Indoor units	H2	H2, H3, H4	H2, H3, H4, H5, H6, H7	0,5

PIPES DIAMETER (I.U.)

Type capacity of indoor units --->		36	45	56	71	100	125
Liquid pipe diameter	mm\inch"	6,35(1/4")	6,35(1/4")	6,35(1/4")	9,52(3/8")	9,52(3/8")	9,52(3/8")
Gas pipe diameter	mm\inch"	12,7(1/2")	12,7(1/2")	12,7(1/2")	15,88(5/8")	15,88(5/8")	15,88(5/8")

Indoor units table

Hi-wall units						
	Air flowrate (h.m.l.)	Dry	Fan speeds	Sound pressure(h.m.l.)	Dimension (HxWxD)	Net weight
AWS36PH	m ³ /h 720-600-420	l/h 1,9	3 + Auto	dB(A) 35-31-27	mm 285x995x203	kg 12
AWS45PH	m ³ /h 720-600-420	l/h 1,9	3 + Auto	dB(A) 35-31-27	mm 285x995x203	kg 12
AWS56PH	m ³ /h 780-660-480	l/h 2,1	3 + Auto	dB(A) 38-34-30	mm 285x995x203	kg 12
AWS71PH	m ³ /h 1140-1020-840	l/h 4,0	3 + Auto	dB(A) 41-37-34	mm 330x1.140x228	kg 21

Cassette units						
ASS36PH	m ³ /h 700-600-500	l/h 1,2	3 + Auto	dB(A) 43-40-37	mm 273x575x575	kg 16
ASS45PH	m ³ /h 750-630-530	l/h 2,3	3 + Auto	dB(A) 44-40-37	mm 273x575x575	kg 18
ASS56PH	m ³ /h 750-630-530	l/h 2,3	3 + Auto	dB(A) 44-40-37	mm 273x575x575	kg 18
ASGM0918 (grille)	-	-	-	-	mm 41x730x730	kg 2,5
ASS71PH (with grille)	m ³ /h 1140-1020-840	l/h 3,6	3 + Auto	dB(A) 47-45-41	mm 338x860x860	kg 22
ASG0025E (grille)	-	-	-	-	mm 30x860x860	kg 6
ASS100PH (with grille)	m ³ /h 1920-1680-1320	l/h 4,6	3 + Auto	dB(A) 53-50-46	mm 338x1150x860	kg 27
ASS125PH (with grille)	m ³ /h 1920-1680-1320	l/h 6,3	3 + Auto	dB(A) 53-50-46	mm 338x1150x860	kg 27
ASG3648E (grille)	-	-	-	-	mm 30x1150x860	kg 8

Ducted units						
ADS36PH	m ³ /h 600-510-440	l/h 1,5	3 + Auto	dB(A) 45-43-40	mm 266x926x571	kg 30
2-way duct (200 mm each) Plenum	-	-	-	-	mm 266x926x200	kg 6
ADS45PH	m ³ /h 875-600-400	l/h 2,3	3 + Auto	dB(A) 45-38-33	mm 266x1132x571	kg 35
ADS56PH	m ³ /h 875-600-400	l/h 2,3	3 + Auto	dB(A) 45-38-33	mm 266x1132x571	kg 35
3-way duct (200 mm each) Plenum	-	-	-	-	mm 266x1132x200	kg 7,5
ADS71PH	m ³ /h 1080-900-780	l/h 3,5	3 + Auto	dB(A) 34-30-27	mm 310x1000x630	kg 32
ADS100PH	m ³ /h 1800-1560-1260	l/h 4,2	3 + Auto	dB(A) 38-33-31	mm 310x1480x630	kg 47
ADS125PH	m ³ /h 1980-1560-1320	l/h 6,6	3 + Auto	dB(A) 40-37-33	mm 310x1480x630	kg 47

Floor/ceiling units						
FC36PHG	m ³ /h 700-590-500	l/h 1,3	3 + Auto	dB(A) 47-43-38	mm 680x900x190	kg 23,5
FC45PHG	m ³ /h 830-760-665	l/h 2,3	3 + Auto	dB(A) 52-49-46	mm 680x900x190	kg 23,5
FC56PHG	m ³ /h 830-760-665	l/h 2,3	3 + Auto	dB(A) 52-49-46	mm 680x900x190	kg 23,5

Ceiling units						
ACS71PH	m ³ /h 1098-900-840	l/h 3,0	3 + Auto	dB(A)38-36-33	mm 210x1180x680	kg 25
ACS100PH	m ³ /h 1650-1380-1200	l/h 3,9	3 + Auto	dB(A) 41-38-35	mm 210x1595x680	kg 33
ACS125PH	m ³ /h 1800-1560-1320	l/h 5,6	3 + Auto	dB(A) 43-40-37	mm 210x1595x680	kg 35

NB: For the indoor units capacity see the matching table.

Controls & accessories

Infrared remote controller / i.u. HIGH-WALL

Infrared remote controller to be used with high-wall indoor units



Infrared remote controller / i.u. AS-FC

Infrared remote controller to be used with cassette and floor/ceiling indoor units



Infrared remote controller / i.u. AC

Infrared remote controller to be used with underceiling indoor units



Infrared remote controller with receiver

Infrared remote controller to be used, in matching with a special infrared receiver, with the full range of indoor units; it shows the operation status of the air-conditioner



Standard wired remote controller

Standard wired remote controller with full features control, self-diagnostic and centralized programming capabilities



Simplified wired remote controller

Simplified wired remote controller to be used with the full range of indoor units; it controls all the main features



Remote sensor

Remote sensor to be used with the full range of indoor units to detect the room temperature when no remote controller sensor or body sensor is used: suggested for air-conditioner systems without remote controller



Schedule timer

Schedule timer able to manage up to 64 indoor units with customized programming of all features, on/off cycles, etc.



Optional distribution joint kit

DDVI 16

capacity after distribution joint is 16.0 kW or less

DTVP

capacity after distribution joint is 28.0 kW or less

INDOOR UNIT CONNECTION PIPING (ø1, ø2, ø3, ø4)

Units : mm (in.)

Indoor unit	type 36	type 45	type 56	type 71	type 100	type 125
Gas pipe		12.7 (1/2)			15.88 (5/8)	
Liquid pipe		6.53 (1/4)			9.52 (3/8)	

DDVI16

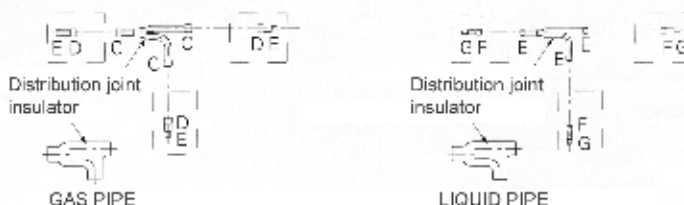

CONNECTION DIMENSIONS OF THE PARTS (pipes inner diameter)

Units : mm (in.)

Position	Part A	Part B	Part C	Part D	Part E	Part F	Part G
Dimension	ø 26.58	ø 25.4	ø 19.05	ø 15.88	ø 12.7	ø 9.52	ø 6.35

DTVP

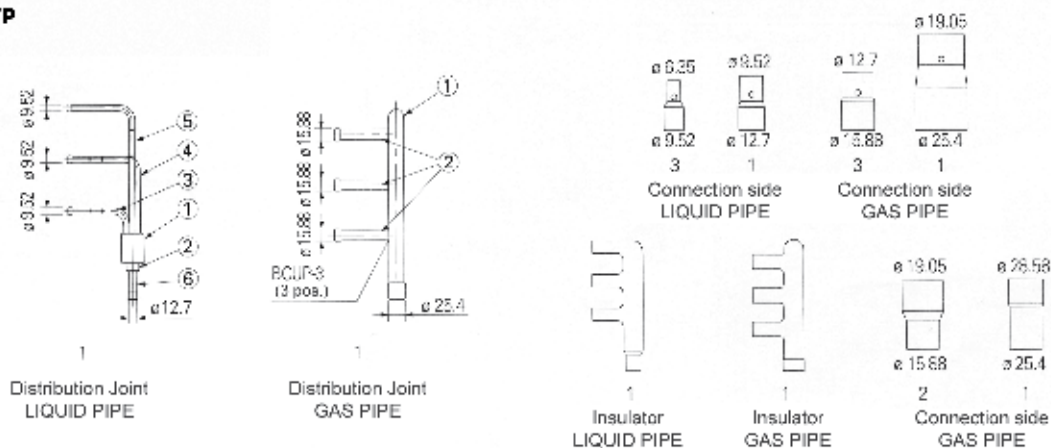

SPLIT/PACKAGE ON OFF



ON OFF

Split and package on/off, heat pump and low ambient, up to 14 kW of thermal capacity for mono and multi applications, hi-wall, floor/ceiling or built-in (cassette) types.

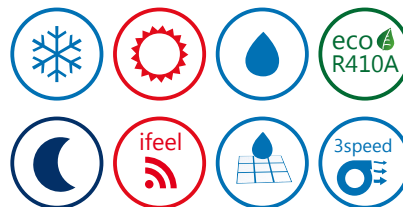

AW 726/735 H

- Automatic change-over between cooling and heating modes
- Infrared remote control; 24h digital timer; 4-addressing possibility
- Double temperature sensor (on the unit and inside the remote control)
- "I Feel" feature, granting the best comfort conditions
- Dry function
- Three-speed tangential fan by remote control
- Night set-back capability
- Usable also without remote control
- Horizontal flap by remote control: swinging or six fixed positions
- Vertical flap with rear protection grille, allowing a safe installation of the indoor unit also at low distance from the floor (min. 1,7 mt)
- Washable filters; active carbon filters (optional)
- Double condensate discharge (right/left) to make easier the installation
- Auto restart after a power supply black out
- Electronic protection of the indoor units: anti-freeze; heating function disabled during defrosting cycle, electronic protection against over-pressures
- High efficiency rotary compressor
- Self-diagnostic functions

PRODUCT NAME		AW726H		AW735H		
Indoor unit		AW726HL/F		AW735HL/F		
Outdoor unit		AE726SH		AE735SH		
Features		Units	Cooling	Heating	Cooling	Heating
Cooling/Heating capacity		kW	2,65	3,00	3,4	3,7
		BTU/h	9.040	10.230	11.600	12.620
		kcal/h	2.280	2.580	2.920	3.180
Energy label class		ABCDEFG	A	A	A	A
E.E.R. / C.O.P.		(kW/kW)	3,44	3,80	3,21	3,61
Air flowrate Indoor (h.m.l.)		m ³ /h	450-400-370		470-430-390	
Dehumidification		l/h	1,2	-	1,5	-
Fan speeds (Indoor / Outdoor)		n°	3 + Auto/1		3 + Auto/1	
Sound pressure Indoor (h.m.l.)		dB(A)	41-36-32		41-36-32	
Sound pressure Outdoor (h.)		dB(A)	37		40	
Power supply		V/Ph/Hz	230/1/50		230/1/50	
Power input		kW	0,770	0,790	1,060	1,025
Running consumption		A	3,50	3,60	5,40	5,20
Annual energy cons.-cooling(500h)-Dir. 2002/31/CE		kWh	385	-	530	-
Compressor type			Rotary		Rotary	
Refrigerant type			R410A		R410A	
Liquid pipe diameter		mm(inch")	6,35(1/4")		6,35(1/4")	
Gas pipe diameter		mm(inch")	9,52(3/8")		12,7(1/2")	
Max. pipe lenght with gas standard charge		m	7,5		7,5	
Max. pipe lenght with gas additional charge		m	15		15	
Gas additional charge		gr/m	20		20	
Max. height between units (Outdoor on top)		m	7		7	
Max. height between units (Indoor on top)		m	7		7	
Net weight Indoor / Outdoor		Kg	8/35		8/35	
Net dimension Indoor (H./W./D.)		mm	270x805x214		270x805x214	
Net dimension Outdoor (H./W./D.)		mm	540x700x265		540x700x265	

The technical data here indicated are in compliance with the European standard EN14511 - Directive 2002/31/EC

MONOSPLIT ON/OFF

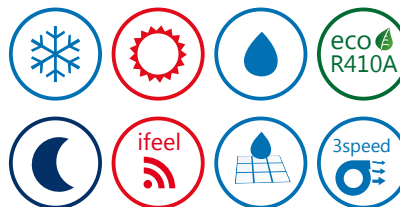

AW 752/764_H/764_{H3}

- Automatic change-over between cooling and heating modes
- Available in single-phase and three-phase versions (764H3)
- Infrared remote control; 24h digital timer; 4-addressing possibility
- Double temperature sensor (on the unit and inside the remote control)
- "I Feel" feature, granting the best comfort conditions
- Dry function
- Three-speed tangential fan by remote control
- Night set back capability
- Usable also without remote control
- Horizontal flap by remote control: swinging or six fixed positions
- Vertical flap with rear protection grille, allowing a safe installation of the indoor unit also at low distance from the floor (min. 1,7 mt)
- Washable air filters; active carbon filters (optional)
- Double condensate discharge (right/left) to make easier the installation
- Auto restart after a power supply black out
- Electronic protection of the indoor units: anti-freeze; heating function disabled during defrosting cycle, electronic protection against over-pressures
- Anti-freeze protection of the outdoor unit
- High efficiency rotary compressor
- Self-diagnostic functions
- Single-phase and three-phase (764H3) power supply

PRODUCT NAME		AW752H		AW764H		AW764H3	
Indoor unit		AW752HL		AW764HL		AW764HL	
Outdoor unit		AE752SH		AE764SH		AE764SH3	
Features	Units	Cooling	Heating	Cooling	Heating	Cooling	Heating
Cooling/Heating capacity	kW	5,00	5,80	6,60	7,80	6,80	8,00
	BTU/h	17.100	19.780	22.500	26.600	23.200	27.280
	kcal/h	4.300	4.990	5.676	6.710	5.848	6.880
Energy label class	ABCDEFG	A	A	A	A	A	A
E.E.R. / C.O.P.	(kW/kW)	3,23	3,82	3,22	3,63	3,24	3,64
Air flowrate Indoor (h.m.l.)	m³/h	880-710-580		880-710-580		880-710-580	
Dehumidification	l/h	1,5	-	2,0	-	2,0	-
Fan speeds (Indoor / Outdoor)	n°	3 + Auto/1		3 + Auto/1		3 + Auto/1	
Sound pressure Indoor (h.m.l.)	dB(A)	46-43-38		49-43-38		49-43-38	
Sound pressure Outdoor (h.)	dB(A)	43		47		47	
Power supply	V/Ph/Hz	230/1/50		230/1/50		400/3N/50	
Power input	kW	1,55	1,52	2,05	2,15	2,10	2,20
Running consumption	A	7,00	6,70	9,20	9,50	4,10	4,30
Annual energy cons.-cooling(500h)-Dir. 2002/31/CE	kWh	775	-	1025	-	1050	-
Compressor type		Rotary		Rotary		Rotary	
Refrigerant type		R410A		R410A		R410A	
Liquid pipe diameter	mm[inch"]	6,35[1/4"]		6,35[1/4"]		6,35[1/4"]	
Gas pipe diameter	mm[inch"]	12,7[1/2"]		15,88[5/8"]		15,88[5/8"]	
Max. pipe lenght with gas standard charge	m	10		12,5		12,5	
Max. pipe lenght with gas additional charge	m	20		30		30	
Gas additional charge	gr/m	20		25		25	
Max. height between units (Outdoor on top)	m	15		15		15	
Max. height between units (Indoor on top)	m	15		15		15	
Net weight Indoor / Outdoor	Kg	12/57		12/71		12/71	
Net dimension Indoor (H./W./D.)	mm	285x995x240		285x995x240		285x995x240	
Net dimension Outdoor (H./W./D.)	mm	630x830x305		735x940x340		735x940x340	

The technical data here indicated are in compliance with the European standard EN14511 - Directive 2002/31/CE



ATTACCHI RAPIDI AEROQUIP

cooling only

Ulisse 13 PCLA

Ulisse 10 CLA

- Floor console, cooling only
- Only 24 cm depth, suitable for fixed or moveable floor installations
- Small condensing case, specifically projected to be placed on balcony or window
- Automatic condensate vaporization through the case
- Infrared remote control with 24h digital timer and 4-addressing possibility, night set back, start-up of air-conditioning or dehumidifying or ventilation only modes, temperature digital adjustment and room temperature control by a special sensor inside the remote control
- Double temperature sensor (on remote control / on indoor unit)
- "I Feel" feature
- Dry function
- Three-speed fan by remote control
- Frontal air-intake, making possible its placement even between two walls
- AeroQuip quick connectors to easily disconnect and re-connect the outdoor unit for a fixed installation
- Adjustable air louver, granting the best fresh air diffusion
- Washable air filters
- Auto restart after a power supply black out
- Electronic protection against over-pressures
- High efficiency rotary compressor
- Accessories for the outside fixed installation of the case supplied with the unit
- Optional pipe-extension kits connecting Indoor and Outdoor units (2 and 4m)

PRODUCT NAME		ULISSE 10CLA	ULISSE 13PCLA
Features	Units	Cooling	Cooling
	kW	2,98	4,00
Capacity	BTU/h	10.160	13.640
	kcal/h	2.560	3.440
Energy label class	ABCDEFG	A	A
E.E.R. /C.O.P.	(kW/kW)	3,22	3,21
Air flowrate (h./h.-m.-l.)	m ³ /h	370	400-375-335
Dehumidification	l/h	1,2	1,9
Fan speeds (Indoor / Outdoor)	n°	3 + Auto / 1	3 + Auto / 1
Sound pressure Indoor (h.m.l.)	dB(A)	36-36-34	37-36-34
Sound pressure Outdoor (h.)	dB(A)	45	42
Power supply	V/Ph/Hz	230/1/50	230/1/50
Running consumption	kW	0,925	1,25
Annual energy consumption-cooling mode(500h)-Dir. 2002/31/CE	kWh	463	625
Refrigerant type		R410A	R410A
Standard pipe lenght	m	2	2
Additional pipe lenght	m	2-4	2-4
Max. height between units (Outdoor on the top)	m	1,2	1,2
Max. height between units (Indoor on the top)	m	5,2	5,2
Net weight Indoor / Outdoor	Kg	44/9,5	44/15
Net dimension Indoor (H./W./D.)	mm	790x580x245	790x580x245
Net dimension Outdoor (H./W./D.)	mm	435x440x230	490x525x250

The technical data here indicated are in compliance with the European standard EN14511 - Directive 2002/31/EC

FLOOR SPLIT



heat pump

Ulisse 10 HLA

ATTACCHI RAPIDI AEROQUIP

- Floor console, cooling and heat pump
- Only 24 cm depth, suitable for fixed or moveable floor installations
- Small condensing case, specifically projected to be placed on balcony or window
- Infrared remote control with 24h digital timer and 4-addressing possibility, night set back, start-up of air-conditioning or dehumidifying or ventilation only modes, temperature digital adjustment and room temperature control by a special sensor inside the remote control
- Double temperature sensor (on remote control / on indoor unit)
- "I Feel" feature
- Dry function
- Three-speed fan by remote control
- Frontal air-intake, making possible its placement even between two walls
- AeroQuip quick connectors to easily disconnect and re-connect the outdoor unit for a fixed installation
- Adjustable air louver, granting the best fresh air diffusion
- Washable air filters
- Auto restart after a power supply black out
- Electronic protection against over-pressures
- High efficiency rotary compressor
- Accessories for the outside fixed installation of the case supplied with the unit
- Optional pipe-extension kits connecting Indoor and Outdoor units (2 and 4m)

PRODUCT NAME	ULISSE 10HLA		
Features	Units	Cooling	Heating
	kW	2,98	3,34
Capacity	BTU/h	10.160	11.390
	kcal/h	2.560	2.870
Energy label class	ABCDEFG	A	A
E.E.R. /C.O.P.	(kW/kW)	3,22	3,67
Air flowrate (h./h.-m.-l.)	m ³ /h	370	
Dehumidification	l/h	1,2	
Fan speeds (Indoor / Outdoor)	n°	3 + Auto / 1	
Sound pressure Indoor (h.m.l.)	dB(A)	35-31-29	
Sound pressure Outdoor (h.)	dB(A)	39	
Power supply	V/Ph/Hz	230/1/50	
Running consumption	kW	0,925	0,910
Annual energy consumption-cooling mode(500h)-Dir. 2002/31/CE	kWh	463	
Refrigerant type		R410A	
Standard pipe lenght	m	2	
Additional pipe lenght	m	2-4	
Max. height between units (Outdoor on the top)	m	1,2	
Max. height between units (Indoor on the top)	m	5,2	
Net weight Indoor / Outdoor	Kg	44/15	
Net dimension Indoor (H./W./D.)	mm	790x580x245	
Net dimension Outdoor (H./W./D.)	mm	490x525x250	

The technical data here indicated are in compliance with the European standard EN14511 - Directive 2002/31/EC



MONOSPLIT LOW AMBIENT

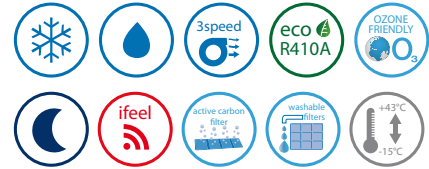

cooling only

AW 726/735 CL

- Able to operate with an outdoor air temperature up to -15°C
- Infrared remote control; 24h digital timer; 4-addressing possibility
- Double temperature sensor (on the unit and inside the remote control)
- "I Feel" feature, granting the best comfort conditions
- Dry function
- Three-speed tangential fan by remote control
- Night set-back capability
- Usable also without remote control
- Horizontal flap by remote control: swinging or six fixed positions
- Vertical flap with rear protection grille, allowing safe installations of the indoor unit even at any height from the floor (min. 1,7 m.) (EN60335 safety standard)
- Washable filters; active carbon filters (optional)
- Double condensate discharge (right/left) to make easier the installation
- Auto restart after a power supply black out
- Electronic protection against over-pressures
- High efficiency rotary compressor
- Self-diagnostic functions

MATCHING		AW726CL	AW735CL
Indoor unit		AW726CL/F	AW735CL/F
Outdoor unit		AE726SCL	AE735SCL
Features	Units	Cooling	Cooling
Cooling capacity	kW	2,70	3,40
Energy label class	ABCDEFG	A	A
E.E.R.	(kW/kW)	3,51	3,24
Air flowrate Indoor (h.-m.-l.)	m ³ /h	450-400-370	470-430-390
Dehumidification	l/h	0,8	1,5
Fan speeds (Indoor / Outdoor)	n°	3 + Auto/1	3 + Auto/1
Sound pressure Indoor (h.-m.-l.)	dB(A)	41-36-32	41-36-32
Sound pressure Outdoor (h.)	dB(A)	37	40
Power supply	V/Ph/Hz	230/1/50	230/1/50
Power input	kW	0,770	1,050
Running consumption	A	3,40	4,70
Annual energy cons.- cooling (500h) - Dir.2002/31/CE	kWh	385	525
Compressor type		Rotary	Rotary
Refrigerant type		R410A	R410A
Liquid pipe diameter	mm[inch"]	6,35[1/4"]	6,35[1/4"]
Gas pipe diameter	mm[inch"]	9,52[3/8"]	12,7[1/2"]
Max. pipe lenght with gas standard charge	m	7,5	7,5
Max. pipe lenght with gas additional charge	m	15	15
Gas additional charge	gr/m	20	20
Max. height between units (Outdoor on top)	m	7	7
Max. height between units (Indoor on top)	m	7	7
Net weight Indoor / Outdoor	Kg	8/34	8/34
Net dimension Indoor (H./W./D.)	mm	270x805x214	270x805x214
Net dimension Outdoor (H./W./D.)	mm	540x700x265	540x700x265

The technical data here indicated are in compliance with the European standard EN14511 - Directive 2002/31/EC

MONOSPLIT LOW AMBIENT



cooling only

AW 752 CL/CL3

- Able to operate with an outdoor air temperature up to -15°C
- Infrared remote control; 24h digital timer; 4-addressing possibility
- Double temperature sensor (on the unit and inside the remote control)
- "I Feel" feature, granting the best comfort conditions
- Dry function
- Three-speed tangential fan by remote control
- Night set-back capability
- Usable also without remote control
- Horizontal flap by remote control: swinging or six fixed positions
- Vertical flap with rear protection grille, allowing safe installations of the indoor unit even at any height from the floor (min. 1,7 m.) (EN60335 safety standard)
- Washable filters; active carbon filters (optional)
- Double condensate discharge (right/left) to make easier the installation
- Auto restart after a power supply black out
- Electronic protection against over-pressures
- High efficiency rotary compressor
- Self-diagnostic functions
- Single-phase and three-phase versions

PRODUCT NAME		AW752CL	AW752CL3
Indoor unit		AW752CL	AW752CL
Outdoor unit		AE752SCL	AE752SCL3
Features	Units	Cooling	Cooling
Cooling capacity	kW	5,20	5,30
Energy label class	ABCDEFG	A	A
E.E.R.	(kW/kW)	3,25	3,21
Air flowrate Indoor (h.-m.-L.)	m ³ /h	880-710-580	880-710-580
Dehumidification	l/h	2,0	2,0
Fan speeds (Indoor / Outdoor)	n°	3 + Auto/1	3 + Auto/1
Sound pressure Indoor (h.-m.-L.)	dB(A)	46-43-38	46-43-38
Sound pressure Outdoor (h.)	dB(A)	43	44
Power supply	V/Ph/Hz	230/1/50	400/3N/50
Power input	kW	1,60	1,65
Running consumption	A	7,10	3,40
Annual energy cons.-cooling(500h) - Dir.2002/31/CE	kWh	800	825
Compressor type		Rotary	Rotary
Refrigerant type		R410A	R410A
Liquid pipe diameter	mm(inch")	6,35(1/4")	6,35(1/4")
Gas pipe diameter	mm(inch")	12,7(1/2")	12,7(1/2")
Max. pipe lenght with gas standard charge	m	10	10
Max. pipe lenght with gas additional charge	m	20	20
Gas additional charge	gr/m	20	20
Max. height between units (Outdoor on top)	m	15	15
Max. height between units (Indoor on top)	m	15	15
Net weight Indoor / Outdoor	Kg	12/55	12/55
Net dimension Indoor (H./W./D.)	mm	285x995x240	285x995x240
Net dimension Outdoor (H./W./D.)	mm	630x830x305	630x830x305

The technical data here indicated are in compliance with the European standard EN14511 - Directive 2002/31/CE



MONOSPLIT LOW AMBIENT

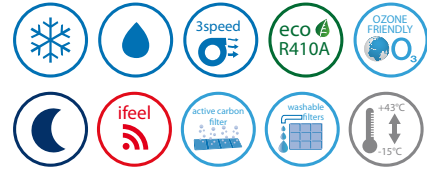

cooling only

AW 764 CL3

- Able to operate with an outdoor air temperature up to -15°C
- Three-phase (400/3N/50Hz) power supply
- Infrared remote control; 24h digital timer; 4-addressing possibility
- Double temperature sensor (on the unit and inside the remote control)
- "I Feel" feature, granting the best comfort conditions
- Dry function
- Three-speed tangential fan by remote control
- Night set-back capability
- Usable also without remote control
- Horizontal flap by remote control: swinging or six fixed positions
- Vertical flap with rear protection grille, allowing safe installations of the indoor unit even at any height from the floor (min. 1,7 m.) (EN60335 safety standard)
- Washable filters; active carbon filters (optional)
- Double condensate discharge (right/left) to make easier the installation
- Auto restart after a power supply black out
- Electronic protection against over-pressures
- High efficiency rotary compressor
- Self-diagnostic functions

PRODUCT NAME		AW764CL3
Indoor unit		AW764CL
Outdoor unit		AE764SCL3
Features	Units	Cooling
Cooling capacity	kW	6,50
Energy label class	ABCDEFG	B
E.E.R.	(kW/kW)	3,13
Air flowrate Indoor (h.-m.-l.)	m ³ /h	880-710-580
Dehumidification	l/h	2,5
Fan speeds (Indoor / Outdoor)	n°	3 + Auto/1
Sound pressure Indoor (h.-m.-l.)	dB(A)	49-43-38
Sound pressure Outdoor (h.)	dB(A)	47
Power supply	V/Ph/Hz	400/3N/50
Power input	kW	2,08
Running consumption	A	4,20
Annual energy cons.- cooling mode (500h) - Directive 2002/31/CE	kWh	1040
Compressor type		Rotary
Refrigerant type		R410A
Liquid pipe diameter	mm(inch")	6,35(1/4")
Gas pipe diameter	mm(inch")	15,88(5/8")
Max. pipe lenght with gas standard charge	m	12,5
Max. pipe lenght with gas additional charge	m	30
Gas additional charge	gr/m	25
Max. height between units (Outdoor on top)	m	15
Max. height between units (Indoor on top)	m	15
Net weight Indoor / Outdoor	Kg	12/71
Net dimension Indoor (H./W./D.)	mm	285x995x240
Net dimension Outdoor (H./W./D.)	mm	735x940x340

The technical data here indicated are in compliance with the European standard EN14511 - Directive 2002/31/EC

MONOSPLIT LOW AMBIENT



cooling only

FC 735/752 CL

- Able to operate with an outdoor air temperature up to -15°C
- Single-phase (230V-1-50Hz) power supply
- Infrared remote control; 24h digital timer; 4-addressing possibility
- Double temperature sensor (on the unit and inside the remote control)
- "I Feel" feature, granting the best comfort conditions
- Dry function
- Three-speed centrifugal fan by remote control
- Night set-back capability
- Usable also without remote control
- Horizontal flap swinging or to be set to on of the six possible fixed position by remote control
- Vertical flap by manual control
- Washable filters; active carbon filters (optional)
- Auto restart after a power supply black out
- Electronic protection against over-pressures
- High efficiency rotary compressor
- Self-diagnostic functions

PRODUCT NAME		FC735CL	FC752CL
Indoor unit		FC735CL	FC752CL
Outdoor unit		AE735SCL	AE752SCL
Features	Units	Cooling	Cooling
Cooling capacity	kW	3,40	5,00
Energy label class	ABCDEF	A	A
E.E.R.	(kW/kW)	3,24	3,23
Air flowrate Indoor (h.-m.-l.)	m ³ /h	670-550-450	715-610-510
Dehumidification	l/h	1,5	1,8
Fan speeds (Indoor / Outdoor)	n°	3 + Auto/1	3 + Auto/1
Sound pressure Indoor (h.-m.-l.)	dB(A)	47-44-39	49-47-40
Sound pressure Outdoor (h.)	dB(A)	40	43
Power supply	V/Ph/Hz	230/1/50	230/1/50
Power input	kW	1,05	1,55
Running consumption	A	4,70	7,00
Annual energy cons.-cooling(500h)-Dir. 2002/31/CE	kWh	525	775
Compressor type		Rotary	Rotary
Refrigerant type		R410A	R410A
Liquid pipe diameter	mm(inch")	6,35(1/4")	6,35(1/4")
Gas pipe diameter	mm(inch")	12,7(1/2")	12,7(1/2")
Max. pipe lenght with gas standard charge	m	7,5	10
Max. pipe lenght with gas additional charge	m	15	20
Gas additional charge	gr/m	20	20
Max. height between units (Outdoor on top)	m	7	15
Max. height between units (Indoor on top)	m	7	15
Net weight Indoor / Outdoor	Kg	23,5/34	23,5/55
Net dimension Indoor (H./W./D.)	mm	680x900x190	680x900x190
Net dimension Outdoor (H./W./D.)	mm	540x700x265	630x830x305

The technical data here indicated are in compliance with the European standard EN14511 - Directive 2002/31/CE



cooling only

FC 752/764 CL3

- Able to operate with an outdoor air temperature up to -15°C
- Three-phase (400-3N-50Hz) power supply
- Infrared remote control; 24h digital timer; 4-addressing possibility
- Double temperature sensor (on the unit and inside the remote control)
- "I Feel" feature, granting the best comfort conditions
- Dry function
- Three-speed centrifugal fan by remote control
- Night set-back capability
- Usable also without remote control
- Horizontal flap swinging or to be set to on of the six possible fixed position by remote control
- Vertical flap by manual control
- Washable filters; active carbon filters (optional)
- Auto restart after a power supply black out
- Electronic protection against over-pressures
- High efficiency rotary compressor
- Self-diagnostic functions

PRODUCT NAME		FC752CL3	FC764CL3
Indoor unit		FC752CL	FC764CL
Outdoor unit		AE752SCL3	AE764SCL3
Features		Units	Cooling
Cooling capacity	kW	5,00	6,50
Energy label class	ABCDEFG	A	B
E.E.R.	(kW/kW)	3,23	3,13
Air flowrate Indoor (h.-m.-L.)	m ³ /h	715-610-510	890-790-640
Dehumidification	l/h	1,8	2,0
Fan speeds (Indoor / Outdoor)	n°	3 + Auto/1	3 + Auto/1
Sound pressure Indoor (h.-m.-L.)	dB(A)	49-47-40	51-49-46
Sound pressure Outdoor (h.)	dB(A)	44	47
Power supply	V/Ph/Hz	400/3N/50	400/3N/50
Power input	kW	1,55	2,08
Running consumption	A	3,20	4,20
Annual energy cons.-cooling(500h)-Dir. 2002/31/CE	kWh	775	1040
Compressor type		Rotary	Rotary
Refrigerant type		R410A	R410A
Liquid pipe diameter	mm(inch")	6,35(1/4")	6,35(1/4")
Gas pipe diameter	mm(inch")	12,7(1/2")	15,88(5/8")
Max. pipe lenght with gas standard charge	m	10	12,5
Max. pipe lenght with gas additional charge	m	20	30
Gas additional charge	gr/m	20	25
Max. height between units (Outdoor on top)	m	15	15
Max. height between units (Indoor on top)	m	15	15
Net weight Indoor / Outdoor	Kg	23,5/55	23,5/71
Net dimension Indoor (H./W./D.)	mm	680x900x190	680x900x190
Net dimension Outdoor (H./W./D.)	mm	630x830x305	735x940x340

The technical data here indicated are in compliance with the European standard EN14511 - Directive 2002/31/EC



cooling only

AS 71/100/125 CL3

- Able to run with an outdoor air temperature up to -15°C
- Three-phase (400-3-50 Hz) power supply
- Infrared remote control; 24h digital timer; 4-addressing possibility
- Double temperature sensor (on the unit and inside the remote control)
- "I Feel" feature, granting the best comfort conditions
- Dry function
- Three-speed centrifugal fan by remote control
- Special system to avoid condensate dripping from air outlet ribs
- Night set-back capability
- Usable also without remote control
- Four horizontal flap by remote control: swinging or six fixed positions
- Washable filters
- Integrated pump for condensate discharge
- Auto restart after a power supply black-out
- Electronic protection against over-pressures
- High efficiency rotary compressor
- Self-diagnostic functions

PRODUCT NAME		AS71CL3	AS100CL3	AS125CL3
Indoor unit		AS71CL	AS100CL	AS125CL
Outdoor unit		AE71SCL3	AE100SCL3	AE125SCL3
Features	Units	Cooling	Cooling	Cooling
Cooling/Heating capacity	kW	7,80	10,40	14,10
Energy label class	ABCDEFGF	B	A	not under Energy labelling
E.E.R. / C.O.P.	(kW/kW)	3,02	3,21	2,82
Air flowrate Indoor (l.-m.-h.)	m ³ /h	680-840-1.020	1.320-1.680-1.920	1.320-1.680-1.920
Dehumidification	l/h	3,0	3,5	5,0
Fan speeds (Indoor / Outdoor)	n°	3 + Auto/ 2-3 (Auto)	3 + Auto/ 2-3 (Auto)	3 + Auto/ 2-3 (Auto)
Sound pressure Indoor (h.-m.-l.)	dB(A)	47-45-44	54-51-47	54-51-47
Sound pressure Outdoor (h.)	dB(A)	48	50	51
Power supply	V/Ph/Hz	400/3N/50	400/3N/50	400/3N/50
Power input	kW	2,58	3,30	5,00
Running consumption	A	5,10	6,60	9,70
Annual energy cons. - cooling (500h)-Dir. 2002/31/CE	kWh	1290	1.650	not under Energy labelling
Compressor type		Rotary	Rotary	Scroll
Refrigerant type		R410A	R410A	R410A
Liquid pipe diameter	mm[inch"]	6,35(1/4")	9,52(3/8")	9,52(3/8")
Gas pipe diameter	mm[inch"]	15,88(5/8")	19,05(3/4")	19,05(3/4")
Max. pipe lenght with gas standard charge	m	7,5	7,5	7,5
Max. pipe lenght with gas additional charge	m	30	40	40
Max. height between units (Outdoor on top)	m	15	25	25
Max. height between units (Indoor on top)	m	15	25	25
Net weight Indoor (with grille) / Outdoor	Kg	22/71	27/104	27/128
Net dimension Indoor (with grille) (H./W./D.)	mm	338x860x860	368x1.150x860	368x1.150x860
Net dimension Outdoor (H./W./D.)	mm	735x940x340	1.235x940x340	1.235x940x340

The technical data here indicated are in compliance with the European standard EN14511 - Directive 2002/31/EC

SISTEMI VRF



VRF

Two/Three way modular systems
for installations up to 135 kW/48HP
max 3 outdoor units & 40 indoor units

Multiset V.R.F. DC Inverter

Multiset DC Inverter systems demand the respect of precise rules in the engineering of a refrigerant circuit

Argoclima gives to system engineers all support and accessories necessary for a correct implementation of an air conditioner system.

- Engineering and design software
- Distribution kits
- Expansion valves with electronic control
- Accessories to change the air with outside

ARGOCLIMA MULTISSET DESIGN SUPPORT SOFTWARE

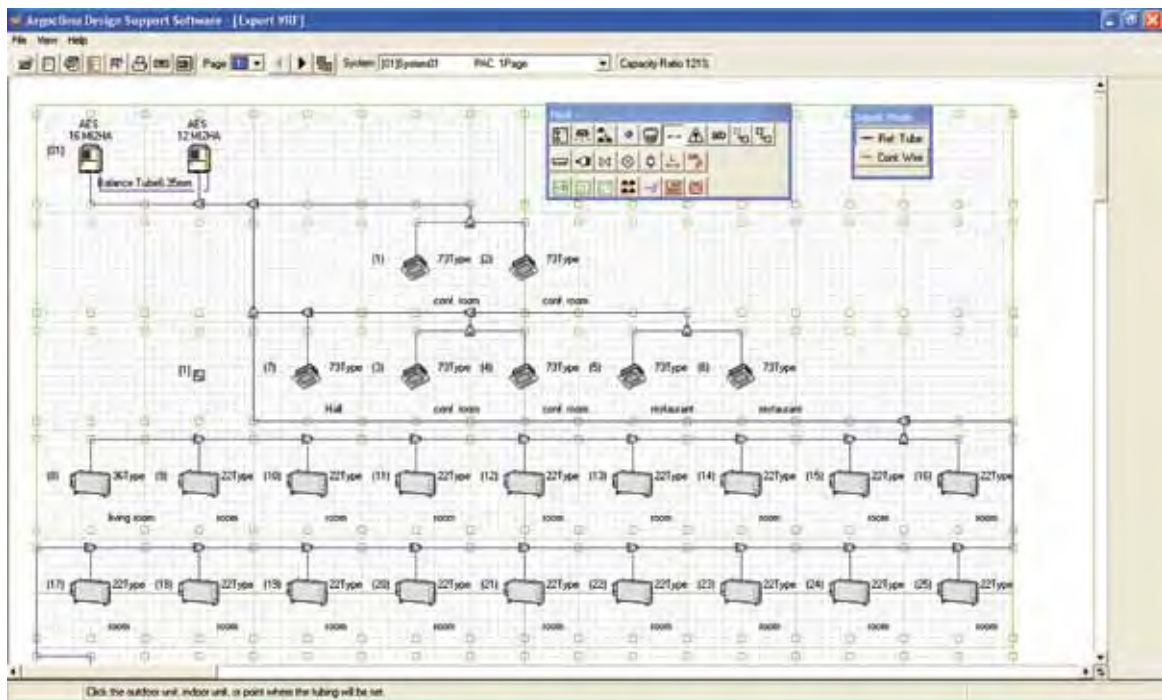

Our organization of Argo technicians and engineers is at Your disposal for the development of projects, the realization of CAD designs, the test/start of the system and the after-sale technical service.

Multiset Vrf Systems Advantages

FOR THOSE WHO DESIGN AND WHO PROPOSE



CONSIDERABLE FLEXIBILITY OF THE TRACK: The high length of refrigerant pipes between indoor and outdoor units makes easier the installation adjustment to the configuration of the building; also the large distances between indoor and outdoor units allow to easily choose the best location for the condensing units.



VERSATILE CONTROL SYSTEM: The control system allows numerous combinations of individual control, group control and system control.



EASY MODIFICATIONS AND IMPLEMENTATIONS: If it was intended in the design phase, you can expand the system with the addition of indoor and outdoor units in a simple and practical way.



FLEXIBLE MANAGEMENT: The system can have a power ratio between indoor and outdoor units from 50% to 130%.

FOR THOSE WHO PURCHASE AND WHO INSTALL



COST REDUCTION The system uses only two pipes (three in case of systems with heat recovery): the cost and installation time are thus reduced.



EASY INSTALLATION OF CONTROL SYSTEM: The control system uses a transmission circuit formed by two wires without polarity; in this way, you avoid errors and significantly reduces the time required for the connection.



MINIMAL INVASIVENESS IN THE BUILDING: Pipes small sizes don't allow to excessively pollute the building in which the system will be installed. This advantage is particularly important in case of structures already existing or under renovation.



INSTALLATION TIME REDUCTION: The accessories for connecting pipes and the modular type of mounting facilitate and accelerate the time required for installation.

FOR THOSE WHO USE AND WHO MAKE MAINTENANCE



CUSTOMIZED SELECTION: The user can select at will the environmental conditions of each area or room to obtain an optimal climate.



A COMFORTABLE ENVIRONMENT: The temperature control reduces the time necessary to achieve the desired conditions, keeping them steadily.



EASY USE OF THE REMOTE CONTROL: Remote Control allows you to obtain very easily maximum performances from each indoor unit. You can easily select the operation mode (dry/cooling/heating/ventilation), the desired temperature, the air flow volume and direction, etc.



HIGH PERFORMANCE ROTARY COMPRESSORS: The advanced design of the compressors together with the LONG-LIFE system, using cyclic compressors in multiple installations, offer extended service life.



SELF-DIAGNOSIS FUNCTION: In case of failure, both the remote devices and the outdoor units provide the information necessary to become aware of the location and characteristics of the failure, reducing repair and maintenance time.

AES04MMIH/H3	Cooling:	11,2 kW
	Heating:	12,5 kW
AES05MMIH/H3	Cooling::	14 kW
	Heating:	16 kW
AES06MMIH/H3	Cooling::	15,5 kW
	Heating:	17,6 kW



Mini Multiset V.R.F. DCI

The Mini Multiset V.R.F. DC Inverter System is the new frontier of technology, specifically thought for residential and light commercial applications

DCI High efficiency DC Inverter Compressor, circuit DCI PAM (Dc Inverter Pulse Amplitude modulation), maximum of 9 indoor units connectable to 1 outdoor unit (model AES06MMIH). DC Inverter Fan

V.R.F. Variable Refrigerant Flow: continuous regulation of the refrigerant flow rate in the circuit of an air conditioning system able to give the best in term of comfort, with very high efficiency levels (E.E.R. up to 4,06 - model AES04MMIH)

R410A The most ecological and efficient refrigerant available for air conditioning systems of this level of thermal capacity

COMPACT Reduced dimensions of the outdoor unit

WIDE RANGE Three sizes available: 4-5-6 HP

230/400 VOLT Single-phase (230/1/50) and Three-phase (400/3/50) power supply

150 m Refrigerant circuit of a maximum length of 150 m, to be realized with a big save of time thanks to the reduced pipe dimension and to the simple tree structure that makes widening easy, not requiring any installation of expensive concentrator apparatus

LAN (Local Area Network) For the interconnection of all the indoor/outdoor units and the system controls, realized with two wiring cables without polarization; the intelligent controllers are able to auto set all the units, simplifying and reducing to minimum the time-to-start

SILENCE Low sound levels thanks to the special fans and to the careful study of the air movements in suction

WIDE LIMITS The wide range of outdoor air temperature supported allows the operation even in extreme conditions:
 from -10°C to +43°C in cooling mode
 from -20°C to +15°C in heating mode

MATCHIN & CONTROLS Indoor units, controllers (all optional) and accessories are the same as those of 2 and 3 way Multiset V.R.F.DCI

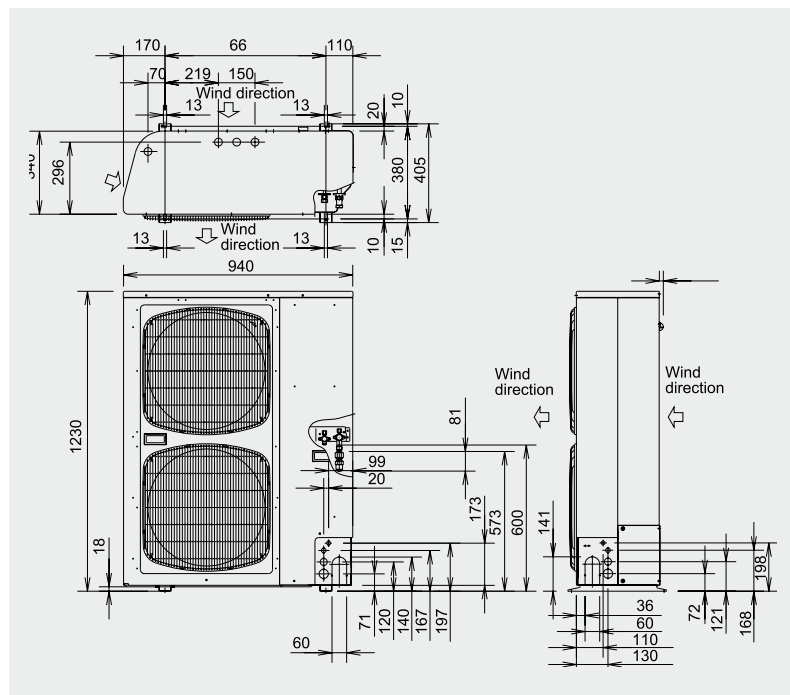

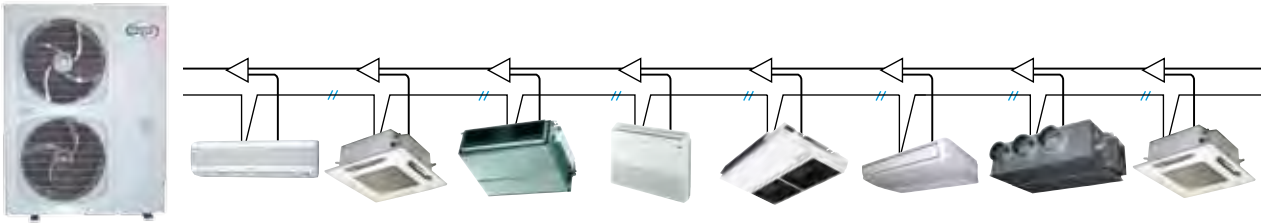

Mini Multiset V.R.F. DCI

■ Limitation of refrigerant piping length

Item	04	05	06
Capacity ratio of indoor unit to outdoor unit	50 - 130%		
Max. number of connectable indoor units	6	8	9
Max. actual piping length	150		
Max. total piping length	200		
Allowable elevation difference	When outdoor unit is installed higher than indoor unit		50
	When outdoor unit is installed lower than indoor unit		40
Max. difference between indoor units	15		

■ Main piping size after distribution

Total capacity after distribution	less than kW	7.1	16
	kW and up	—	7.1
Piping size	Gas pipe (mm)	12.7	15.88
	Liquid pipe (mm)	6.35	9.52

■ Indoor unit connection piping

Indoor unit	Type	22	28	36	45	56	73	106	140	
	HP		0.8	1	1.3	1.6	2	2.5	4	5
Piping size	Gas pipe	12.7						15.88		
	Liquid pipe	6.35						9.52		

INVERTER outdoor units		AES04MMIH/H3		AES05MMIH/H3		AES06MMIH/H3	
Features	units	Cooling	Heating	Cooling	Heating	Cooling	Heating
HP		4		5		6	
Cooling/Heating capacity	kW	11,2	12,5	14,0	16,0	15,5	17,6
	BTU/h	38.200	42.700	47.800	54.600	52.900	60.000
	kcal/h	9.630	10.750	12.040	13.760	13.330	15.140
E.E.R. / C.O.P.	[kW/kW]	4,06	4,34	3,66	4,1	3,39	3,84
Air flowrate (h.)	m ³ /h	6.000		6.000		6.000	
Sound pressure (normal/silent mode)	dB(A)	51/48		51/48		52/49	
Power supply	V/Ph/Hz	230/1/50 - 400/3/50		230/1/50 - 400/3/50		230/1/50 - 400/3/50	
Running consumption	kW	2,76	2,88	3,83	3,90	4,57	4,58
Compressor type		DC Inverter		DC Inverter		DC Inverter	
Refrigerant type		R410A		R410A		R410A	
Liquid pipe diameter	mm(inch")	9,52(3/8")		9,52(3/8")		9,52(3/8")	
Gas pipe diameter	mm(inch")	15,88(5/8")		15,88(5/8")		19,05(3/4")	
Max. number of connectable indoor units	no.	6		8		9	
Max. pipe length	m	150		150		150	
Gas standard charge	Kg	3,5		3,5		3,5	
Max. distance between indoor units	m	15		15		15	
Max. height between units (Outdoor on top)	m	50		50		50	
Max. height between units (Indoor on top)	m	40		40		40	
Net weight Outdoor	Kg	104		104		104	
Net dimension Outdoor (H./W./D.)	mm	1.200x940x340		1.200x940x340		1.200x940x341	



Multiset V.R.F. DCI

DCI + SAC DC Inverter Compressor + Scroll AC Compressor, the perfect matching for a high efficiency system with capacity up to 48HP, automatically modulated by the DCI PAM (Dc Inverter Pulse Amplitude modulation) circuit on a maximum of 40 indoor units connected.

V.R.F. Variable Refrigerant Flow: continuous regulation of the refrigerant flow rate in the circuit of an air conditioning system able to give the best in term of comfort, with very high efficiency levels (COP up to 4,09).

R410A The most ecological and efficient refrigerant available for air conditioning systems of this level of thermal capacity.

TWO WAY Two-way system with possibility of condensing and indoor units increase thanks to the simple tree refrigerant circuit.

THREE WAY New three-way solution with heat recovery, giving the possibility of a simultaneous independent operation in cooling and/or heating modes of each indoor unit.

HFC= -21% Reduction of the total refrigerant volume of about 21% in comparison with the previous systems.

300 m Refrigerant circuit of a maximum length of 300 m, to be realized with a big save of time thanks to the reduced pipe dimension and to the simple tree structure that makes widening easy, not requiring any installation of expensive concentrator apparatus.

LAN (Local Area Network) for the interconnection of all the indoor/outdoor units and the system controls, realized with two wiring cables without polarization; the intelligent controllers are able to auto set all the units, simplifying and reducing to minimum the time-to-start.

LONG LIFE A special electronic system controls the operating cycles of the compressors, distributing the load and extending the efficiency in the time.

BACK UP The system is able to activate the automatic back-up of the condensing units in error or stopped; the sophisticated control system compensates the bad operation of the blocked outdoor unit, distributing the thermal power to the other outdoor units of the multiple configuration system.

SILENCE For the first time the sound levels are lower than 52 dB; thanks to the special fans and to the careful study of the air movements in suction, the sound levels have been reduced of more than 4 dB in comparison with the previous models.

WIDE RANGE The wide range of outdoor air temperature supported allows the operation even in extreme conditions:

from -10°C to +43°C in cooling mode

from -20°C to +15°C in heating mode

FREE PLACE The condensing units in multiple configuration can be installed at a distance of only 10 cm or very far one from the other, even on different stages of the building; this feature makes the system more adaptable to the various circumstances.



Outdoor Units 2-Way Systems

MAIN FEATURES:

- compactness, making units easier to position;
 - smaller pipe works, making material costs lower;
 - flexibility of installation;
 - high efficiency (C.O.P. at the top of the range: 3,90 average cooling/heating for the 8HP units)
 - reduced life cycle costs;
 - accurate capacity control;
 - possibility to choose among a wide range of control options.
- Maximum number of Outdoor units connectable: 3.
 - Maximum total power of the system: 135 kW (48 HP).
 - Maximum number of Indoor units connectable: 40.
 - Twin Rotary DC Inverter compressor, highly efficient at low rotation frequencies.
 - R410A HFC refrigerant.
 - Fan with direct current motor that allows a consumption reduction of about 50% and a speed modulation up to 16 steps in spite of the usual 4 steps of the alternate current motors; this performance increases the efficiency of the thermodynamic system which is able to best adapt to the variations of temperature and thermal load of the rooms.
 - The use of a special oil sensor allows, for the first time in the world, to keep under control the lubrication of the mechanical parts of the compressor.
 - Special air intakes and Double Chamber construction technology allowed to unify the dimensions of the units, making easier the closing up for multiple installations in which two units can be placed at a distance of only 10 cm one from the other, the smaller distance available.
 - Low sound level thanks to a special fan made of resin and a particular resin grille, designed and used for these units in order to minimize air pressure drops.
 - New high efficiency Cross-Arranged heat exchanger with three-way suction, divided in two sections with double control of defrosting cycle.
 - Pressure control automatic and by software on PC.
 - Pipe connection inside the unit frame through a special space to be closed back when the installation is finished.
 - Equipped with Fault-Tolerant system granting in multiple installations the operation of the air conditioning system also in case of total stop of one condensing unit.
 - Support to Long-Life system that, in multiple installations, allows a cyclic use of the condensing units, granting a balance of the compressors activity.
 - Wide range of outdoor air temperature: from -10°C to +43°C in cooling mode and from -20°C to +15°C in heating mode.
 - Maximum length of the refrigerant circuit extended to 300 m.
 - The refrigerant circuit doesn't require distribution apparatus downstream of the unit as it can be realized with a tree structure using only the special distributor accessories; this feature facilitates any type of system widening, by adding both outdoor and indoor units.
 - Three-phase auto sense power supply 380-415/3N/50Hz.

TECHNICAL DATA

2-way INVERTER OUTDOOR UNIT		AES08MI2HA	AES10MI2HA	AES12MI2HA
	Units			
Cooling/Heating capacity	kW	22,40 / 25,00	28,00 / 31,50	33,50 / 37,50
E.E.R. / C.O.P.	(kW/kW)	3,74 / 4,05	3,54 / 4,06	3,50 / 3,91
Air flowrate (h.)	m³/h	9,000	9,600	10,800
Sound pressure (normal/silent mode)	dB(A)	54,5 / 51,5	55 / 52	56 / 53
Sound power (normal mode)	dB(A)	65,5	66,5	67,5
Power supply	V/Ph/Hz	400/3N/50	400/3N/50	400/3N/50
Running consumption (cooling/heating)	kW	5,99 / 6,17	7,90 / 7,75	9,58 / 9,60
Running current	A	9,20 / 9,50	12,30 / 12,00	14,90 / 14,90
Compressor type		Twin Rotary DCI (N°1)	Twin Rotary DCI+Scroll(N°2)	Twin Rotary DCI+Scroll(N°2)
Refrigerant type		R410A	R410A	R410A
Liquid pipe diameter	mm(inch")	9,52(3/8")	9,52(3/8")	12,70(1/2")
Gas pipe diameter (suction)	mm(inch")	19,05(3/4")	22,22(7/8")	25,40(1")
Balance pipe	mm(inch")	6,35(1/4")	6,35(1/4")	6,35(1/4")
Max. pipe lenght	m	300	300	300
Gas standard charge	Kg	12	12	12
Operating limits (cooling/heating)	°C	-10 ~ +43 / -20 ~ +15	-10 ~ +43 / -20 ~ +15	-10 ~ +43 / -20 ~ +15
Capacity ratio of indoor unit to outdoor unit	%	50 - 130	50 - 130	50 - 130
Connectable indoor units	N°	13	16	19
Max. height between units (Outdoor on top)	m	50	50	50
Max. height between units (Indoor on top)	m	40	40	40
Net weight Outdoor	Kg	245	295	295
Net dimension Outdoor (H./W./D.)	mm	1.887x890(+60)x890	1.887x890(+60)x890	1.887x890(+60)x890

2-way INVERTER OUTDOOR UNIT		AES14MI2HA	AES16MI2HA
	Units		
Cooling/Heating capacity	kW	40,00 / 45,00	45,00 / 50,00
E.E.R. / C.O.P.	(kW/kW)	3,45 / 3,91	3,38 / 3,79
Air flowrate (h.)	m³/h	12,000	13,200
Sound pressure (normal/silent mode)	dB(A)	61 / 58	62 / 59
Sound power (normal mode)	dB(A)	71,5	72
Power supply	V/Ph/Hz	400/3N/50	400/3N/50
Running consumption (cooling/heating)	kW	11,60 / 11,50	13,30 / 13,20
Running current	A	18,60 / 18,50	21,30 / 21,20
Compressor type		Twin Rotary DCI+Scroll(N°3)	Twin Rotary DCI+Scroll(N°3)
Refrigerant type		R410A	R410A
Liquid pipe diameter	mm(inch")	12,70(1/2")	12,70(1/2")
Gas pipe diameter (suction)	mm(inch")	25,40(1")	28,58(1-1/8")
Balance pipe	mm(inch")	6,35(1/4")	6,35(1/4")
Max. pipe lenght	m	300	300
Gas standard charge	Kg	13	13
Operating limits (cooling/heating)	°C	-10 ~ +43 / -20 ~ +15	-10 ~ +43 / -20 ~ +15
Capacity ratio of indoor unit to outdoor unit	%	50 - 130	50 - 130
Connectable indoor units	N°	23	26
Max. height between units (Outdoor on top)	m	50	50
Max. height between units (Indoor on top)	m	40	40
Net weight Outdoor	Kg	345	345
Net dimension Outdoor (H./W./D.)	mm	1.887x890(+60)x890	1.887x890(+60)x890

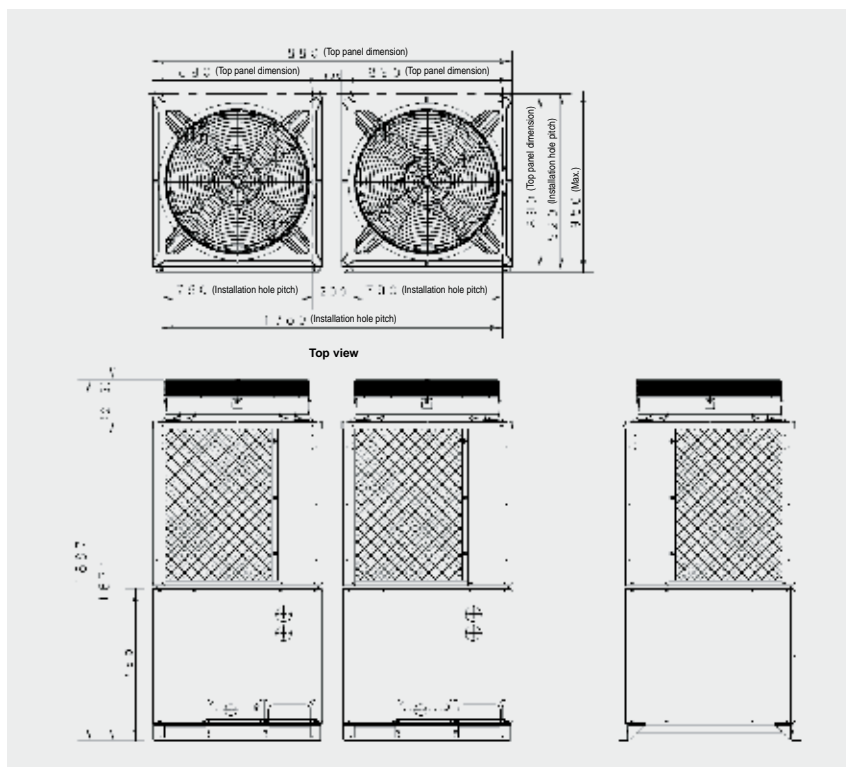

OUTDOOR UNITS MATCHINGS - TECHNICAL DATA

CAPACITY CLASSES (HP)		18 HP	20 HP	22 HP
Outdoor units matchings		AES10+AES08 MI2HA	AES10+AES10 MI2HA	AES12+AES10 MI2HA
	Units			
Cooling/Heating capacity	kW	50,40 / 56,50	56,00 / 63,00	61,50 / 69,00
E.E.R. / C.O.P.	(kW/kW)	3,63 / 4,06	3,54 / 3,80	3,51 / 3,97
Air flowrate (h.)	m ³ /h	9.600 + 9.000	9.600 x 2	10.800 + 9.600
Sound pressure (normal/silent mode)	dB(A)	58 / 55	58 / 55	58,5 / 55,5
Sound power (normal mode)	dB(A)	69	69,5	69,5
Power supply	V/Ph/Hz	400/3N/50	400/3N/50	400/3N/50
Power input (cooling/heating)	kW	13,9 / 13,9	15,8 / 15,5	17,5 / 17,4
Running current (cooling/heating)	A	21,60 / 21,60	24,7 / 24,2	27,2 / 27,0
Compressor type		Twin Rotary+Scroll	Twin Rotary+Scroll	Twin Rotary+Scroll
Refrigerant control		Electr. Exp. Valve	Electr. Exp. Valve	Electr. Exp. Valve
Refrigerant type		R410A	R410A	R410A
Liquid pipe diameter after 1° distributor kit	mm(inch")	15,88(5/8")	15,88(5/8")	15,88(5/8")
Gas pipe diameter after 1° distributor kit	mm(inch")	28,58(1-1/8")	28,58(1-1/8")	28,58(1-1/8")
Diameter of balancing pipe	mm(inch")	6,35(1/4")	6,35(1/4")	6,35(1/4")
Max. pipe lenght	m	300	300	300
Gas standard charge	Kg	12,0 x 2	12,0 x 2	12,0 x 2
Operating limits (cooling/heating)	°C	-10 ~ +43 / -20 ~ +15	-10 ~ +43 / -20 ~ +15	-10 ~ +43 / -20 ~ +15
Capacity ratio of indoor unit to outdoor unit	%	50-130	50-130	50-130
Connectable indoor units	N°	29	33	36
Net weight Outdoor	Kg	295 + 245	295 x 2	295 x 2
Net dimension Outdoor (H./W./D.)	mm	1.887x1.880x890(+60)	1.887x1.880x890(+60)	1.887x1.880x890(+60)

CAPACITY CLASSES (HP)		24 HP	26 HP	28 HP
Outdoor units matchings		AES14+AES10 MI2HA	AES16+AES10 MI2HA	AES16+AES12 MI2HA
	Units			
Cooling/Heating capacity	kW	68,00 / 76,50	73,00 / 81,50	78,50 / 87,50
E.E.R. / C.O.P.	(kW/kW)	3,49 / 3,96	3,44 / 3,88	3,43 / 3,84
Air flowrate (h.)	m ³ /h	12.000 + 9.600	13.200 + 9.600	13.200 + 10.800
Sound pressure (normal/silent mode)	dB(A)	62 / 59	63 / 60	63 / 60
Sound power (normal mode)	dB(A)	72,5	73	73,5
Power supply	V/Ph/Hz	400/3N/50	400/3N/50	400/3N/50
Power input (cooling/heating)	kW	19,5 / 19,3	21,2 / 21,0	22,9 / 22,8
Running current (cooling/heating)	A	30,8 / 30,4	33,6 / 33,3	36,3 / 36,2
Compressor type		Twin Rotary+Scroll	Twin Rotary+Scroll	Twin Rotary+Scroll
Refrigerant control		Electr. Exp. Valve	Electr. Exp. Valve	Electr. Exp. Valve
Refrigerant type		R410A	R410A	R410A
Liquid pipe diameter after 1° distributor kit	mm(inch")	15,88(5/8")	19,05(3/4")	19,05(3/4")
Gas pipe diameter after 1° distributor kit	mm(inch")	28,58(1-1/8")	31,75(1-1/4")	31,75(1-1/4")
Diameter of balancing pipe	mm(inch")	6,35(1/4")	6,35(1/4")	6,35(1/4")
Max. pipe lenght	m	300	300	300
Gas standard charge	Kg	13,0 + 12,0	13,0 + 12,0	13,0 + 12,0
Operating limits (cooling/heating)	°C	-10 ~ +43 / -20 ~ +15	-10 ~ +43 / -20 ~ +15	-10 ~ +43 / -20 ~ +15
Capacity ratio of indoor unit to outdoor unit	%	50-130	50-130	50-130
Connectable indoor units	N°	40	40	40
Net weight Outdoor	Kg	345 + 295	345 + 295	345 + 295
Net dimension Outdoor (H./W./D.)	mm	1.887x1.880x890(+60)	1.887x1.880x890(+60)	1.887x1.880x890(+60)

CAPACITY CLASSES (HP)		30 HP	32 HP	34 HP
Outdoor units matchings		AES16+AES14 MI2HA	AES16+AES16 MI2HA	AES 14+10+10 MI2HA
	Units			
Cooling/Heating capacity	kW	85,00 / 95,00	90,00 / 100,00	96,00 / 108,00
E.E.R. / C.O.P.	(kW/kW)	3,41 / 3,85	3,38 / 3,79	3,50 / 4,00
Air flowrate (h.)	m ³ /h	13.200 + 12.000	13.200 x 2	12.000 + 9.600 x 2
Sound pressure (normal/silent mode)	dB(A)	64,5 / 61,5	65 / 62	63 / 60
Sound power (normal mode)	dB(A)	74,5	75	73,5
Power supply	V/Ph/Hz	400/3N/50	400/3N/50	400/3N/50
Power input (cooling/heating)	kW	24,9 / 24,7	26,6 / 26,4	27,4 / 27,0
Running current (cooling/heating)	A	39,9 / 39,6	42,7 / 42,3	43,1 / 42,5
Compressor type		Twin Rotary+Scroll	Twin Rotary+Scroll	Twin Rotary+Scroll
Refrigerant control		Electr. Exp. Valve	Electr. Exp. Valve	Electr. Exp. Valve
Refrigerant type		R410A	R410A	R410A
Liquid pipe diameter after 1° distributor kit	mm(inch")	19,05(3/4")	19,05(3/4")	19,05(3/4")
Gas pipe diameter after 1° distributor kit	mm(inch")	31,75(1-1/4")	31,75(1-1/4")	31,75(1-1/4")
Diameter of balancing pipe	mm(inch")	6,35(1/4")	6,35(1/4")	6,35(1/4")
Max. pipe lenght	m	300	300	300
Gas standard charge	Kg	13,0 x 2	13,0 x 2	13,0+12,0 x 2
Operating limits (cooling/heating)	°C	-10 ~ +43 / -20 ~ +15	-10 ~ +43 / -20 ~ +15	-10 ~ +43 / -20 ~ +15
Capacity ratio of indoor unit to outdoor unit	%	50-130	50-130	50-130
Connectable indoor units	N°	40	40	40
Net weight Outdoor	Kg	345 x 2	345 x 2	345 + 295 x 2
Net dimension Outdoor (H./W./D.)	mm	1.887x1.880x890(+60)	1.887x1.880x890(+60)	1.887x2.870x890(+60)

OUTDOOR UNITS MATCHINGS - TECHNICAL DATA

CAPACITY CLASSES (HP)		36 HP		38 HP		40 HP	
Outdoor units matchings		AES 16+10+10 MI2HA		AES 16+12+10 MI2HA		AES 16+14+10 MI2HA	
	Units						
Cooling/Heating capacity	kW	101,00 / 113,00		107,00 / 119,00		113,00 / 127,00	
E.E.R. / C.O.P.	(kW/kW)	3,47 / 3,94		3,47 / 3,68		3,45 / 3,91	
Air flowrate (h.)	m ³ /h	13.200 + 9.600 x 2		13.200 + 10.800 + 9.600		13.200 + 12.000 + 9.600	
Sound pressure (normal/silent mode)	dB(A)	63,5 / 60,5		63,5 / 60,5		65 / 62	
Sound power (normal mode)	dB(A)	74		74,5		75	
Power supply	V/Ph/Hz	400/3N/50		400/3N/50		400/3N/50	
Power input (cooling/heating)	kW	29,1 / 28,7		30,8 / 30,6		32,8 / 32,5	
Running current (cooling/heating)	A	45,8 / 45,2		48,0 / 48,0		52,0 / 52,0	
Compressor type		Twin Rotary+Scroll		Twin Rotary+Scroll		Twin Rotary+Scroll	
Refrigerant control		Electr. Exp. Valve		Electr. Exp. Valve		Electr. Exp. Valve	
Refrigerant type		R410A		R410A		R410A	
Liquid pipe diameter after 1° distributor kit	mm(inch")	19,05(3/4")		19,05(3/4")		19,05(3/4")	
Gas pipe diameter after 1° distributor kit	mm(inch")	38,10(1-1/2")		38,10(1-1/2")		38,10(1-1/2")	
Diameter of balancing pipe	mm(inch")	6,35(1/4")		6,35(1/4")		6,35(1/4")	
Max. pipe lenght	m	300		300		300	
Gas standard charge	Kg	13,0+12,0 x 2		13,0+12,0 x 2		13,0 x 2+12,0	
Operating limits (cooling/heating)	°C	-10 ~ +43 / -20 ~ +15		-10 ~ +43 / -20 ~ +15		-10 ~ +43 / -20 ~ +15	
Capacity ratio of indoor unit to outdoor unit	%	50-130		50-130		50-130	
Connectable indoor units	N°	40		40		40	
Net weight Outdoor	Kg	345 + 295 x 2		345 + 295 x 2		345 x 2 + 295	
Net dimension Outdoor (H./W./D.)	mm	1.887x2.870x890(+60)		1.887x2.870x890(+60)		1.887x2.870x890(+60)	

CAPACITY CLASSES (HP)		42 HP		44 HP	
Outdoor units matchings		AES 16+16+10 MI2HA		AES 16+16+12 MI2HA	
	Units				
Cooling/Heating capacity	kW	118,00 / 132,00		124,00 / 138,00	
E.E.R. / C.O.P.	(kW/kW)	3,42 / 3,86		3,43 / 3,83	
Air flowrate (h.)	m ³ /h	13.200 x 2 + 9.600		13.200 x 2 + 10.800	
Sound pressure (normal/silent mode)	dB(A)	65,5 / 62,5		65,5 / 62,5	
Sound power (normal mode)	dB(A)	75,5		76	
Power supply	V/Ph/Hz	400/3N/50		400/3N/50	
Power input (cooling/heating)	kW	34,5 / 34,2		36,2 / 36,0	
Running current (cooling/heating)	A	55,0 / 54,0		57,0 / 57,0	
Compressor type		Twin Rotary+Scroll		Twin Rotary+Scroll	
Refrigerant control		Electr. Exp. Valve		Electr. Exp. Valve	
Refrigerant type		R410A		R410A	
Liquid pipe diameter after 1° distributor kit	mm(inch")	19,05(3/4")		19,05(3/4")	
Gas pipe diameter after 1° distributor kit	mm(inch")	38,10(1-1/2")		38,10(1-1/2")	
Diameter of balancing pipe	mm(inch")	6,35(1/4")		6,35(1/4")	
Max. pipe lenght	m	300		300	
Gas standard charge	Kg	13,0 x 2+12,0		13,0 x 2+12,0	
Operating limits (cooling/heating)	°C	-10 ~ +43 / -20 ~ +15		-10 ~ +43 / -20 ~ +15	
Capacity ratio of indoor unit to outdoor unit	%	50-130		50-130	
Connectable indoor units	N°	40		40	
Net weight Outdoor	Kg	345 x 2 + 295		345 x 2 + 295	
Net dimension Outdoor (H./W./D.)	mm	1.887x2.870x890(+60)		1.887x2.870x890(+60)	

CAPACITY CLASSES (HP)		46 HP		48 HP	
Outdoor units matchings		AES 16+16+14 MI2HA		AES 16+16+16 MI2HA	
	Units				
Cooling/Heating capacity	kW	130,00 / 145,00		135,00 / 150,00	
E.E.R. / C.O.P.	(kW/kW)	3,40 / 3,83		3,38 / 3,79	
Air flowrate (h.)	m ³ /h	13.200 x 2 + 12.000		13.200 x 3	
Sound pressure (normal/silent mode)	dB(A)	66,5 / 63,5		67,0 / 64,0	
Sound power (normal mode)	dB(A)	76,5		77	
Power supply	V/Ph/Hz	400/3N/50		400/3N/50	
Power input (cooling/heating)	kW	38,2 / 37,9		39,9 / 39,6	
Running current (cooling/heating)	A	61,0 / 61,0		64,0 / 64,0	
Compressor type		Twin Rotary+Scroll		Twin Rotary+Scroll	
Refrigerant control		Electr. Exp. Valve		Electr. Exp. Valve	
Refrigerant type		R410A		R410A	
Liquid pipe diameter after 1° distributor kit	mm(inch")	19,05(3/4")		19,05(3/4")	
Gas pipe diameter after 1° distributor kit	mm(inch")	38,10(1-1/2")		38,10(1-1/2")	
Diameter of balancing pipe	mm(inch")	6,35(1/4")		6,35(1/4")	
Max. pipe lenght	m	300		300	
Gas standard charge	Kg	13,0 x 3		13,0 x 3	
Operating limits (cooling/heating)	°C	-10 ~ +43 / -20 ~ +15		-10 ~ +43 / -20 ~ +15	
Capacity ratio of indoor unit to outdoor unit	%	50-130		50-130	
Connectable indoor units	N°	40		40	
Net weight Outdoor	Kg	345 x 3		345 x 3	
Net dimension Outdoor (H./W./D.)	mm	1.887x2.870x890(+60)		1.887x2.870x890(+60)	



Outdoor Units 3-Way Systems

MAIN FEATURES:

- Automatic change-over between cooling and heating modes for each indoor unit; this feature, based on the three-way technology with heat recovery, allows a fully independent operation of each indoor unit.
- R410A HFC refrigerant.
- Twin Rotary DC Inverter compressor, highly efficient at low rotation frequencies, matching with a Scroll Constant-Speed compressor .
- Fan with direct current motor that allows a consumption reduction of about 50% and a speed modulation up to 16 steps in spite of the usual 4 steps of the alternate current motors; this performance increases the efficiency of the thermodynamic system which is able to best adapt to the variations of temperature and thermal load of the rooms .
- The use of a special oil sensor allows, for the first time in the world, to keep under control the lubrication of the mechanical parts of the compressor.
- Special air intakes and Double Chamber construction technology allowed to unify the dimensions of the units, making easy the closing up for multiple installations in which two units can be placed at a distance of only 10 cm one from the other, the smaller distance available.
- Low sound level thanks to a special fan made of resin and a particular resin grille, designed and used for these units in order to minimize air pressure drops.
- New high efficiency Cross-Arranged heat exchanger with three-way suction, divided in two sections with double control of defrosting cycle.
- Pressure control automatic and by software on PC.
- Pipe connection inside the unit frame through a special space to be closed back when the installation is finished.
- Equipped with Fault-Tolerant system granting in multiple installations the operation of the air conditioning system also in case of total stop of one condensing unit.
- Support to Long-Life system that, in multiple installations, allows a cyclic use of the condensing units, granting a balance of the compressors activity.
- "On Demand" feature allows to best use the characteristics of DC Inverter technology, setting three different levels of electric power on which are automatically based the control microprocessors so that to achieve the maximum performances with reduction of electric consumption.
- Extra range of outdoor air temperature: from -10°C to +43°C in cooling mode and from -20°C to +15°C in heating mode.
- Maximum length of the refrigerant circuit extended to 300 m.
- The refrigerant circuit doesn't require distribution apparatus downstream of the unit as it can be realized with a tree structure using only the special distributor accessories; this feature facilitates any type of system widening, by adding both outdoor and indoor units.
- Three-phase auto sense power supply 380-415/3N/50Hz.

TECHNICAL DATA

3-way INVERTER OUTDOOR UNITS		AES08M3H	AES10M3H	AES12M3H
	Units			
Cooling/Heating capacity	kW	22,40 / 25,00	28,00 / 31,50	33,50 / 37,50
E.E.R. / C.O.P.	[kW/kW]	3,78 / 4,09	3,45 / 3,95	3,41 / 3,81
Air flowrate (h.)	m ³ /h	9.000	9.600	10.800
Sound pressure (normal/silent mode)	dB(A)	54,5/51,5	55/52	56/53
Sound power (normal mode)	dB(A)	65,5	66	67
Power supply	V/Ph/Hz	400/3N/50	400/3N/50	400/3N/50
Power input (cooling/heating)	kW	5,93 / 6,11	8,12 / 7,97	9,82 / 9,84
Running current (cooling/heating)	A	9,20 / 9,50	12,30 / 12,0	14,9 / 14,9
Compressor type		Twin Rotary DCInv.+ Scroll CS	Twin Rotary DCInv.+ Scroll CS	Twin Rotary DCInv.+ Scroll CS
Refrigerant type		R410A	R410A	R410A
Liquid pipe diameter	mm(inch")	9,52(3/8")	9,52(3/8")	12,70(1/2")
Gas pipe diameter (suction)	mm(inch")	19,05(3/4")	22,22(7/8")	25,40(1")
Gas pipe diameter (discharge)	mm(inch")	15,88(5/8")	19,05(3/4")	19,05(3/4")
Balance pipe	mm(inch")	6,35(1/4")	6,35(1/4")	6,35(1/4")
Max. pipe length	m	300	300	300
Gas standard charge	Kg	12	12	12
Operating limits (cooling/heating)	°C	-10 ~ +43 / -20 ~ +15	-10 ~ +43 / -20 ~ +15	-10 ~ +43 / -20 ~ +15
Capacity ratio of indoor unit to outdoor unit	%	50 - 130	50 - 130	50 - 130
Connectable indoor units	no.	13	16	19
Max. height between units (Outdoor on top)	m	50	50	50
Max. height between units (Indoor on top)	m	40	40	40
Net weight Outdoor	Kg	290	290	290
Net dimension Outdoor (H./W./D.)	mm	1.887x890x890(+60)	1.887x890x890(+60)	1.887x890x890(+60)

3-way INVERTER OUTDOOR UNITS		AES14M3H	AES16M3H
	Units		
Cooling/Heating capacity	kW	40,00 / 45,00	45,00 / 50,00
E.E.R. / C.O.P.	[kW/kW]	3,45 / 3,91	3,38 / 3,79
Air flowrate (h.)	m ³ /h	12.000	13.200
Sound pressure (normal/silent mode)	dB(A)	60/57	61/58
Sound power (normal mode)	dB(A)	71	72
Power supply	V/Ph/Hz	400/3N/50	400/3N/50
Power input (cooling/heating)	kW	11,6 / 11,5	13,3 / 13,2
Running current (cooling/heating)	A	19,0 / 18,9	21,8 / 21,6
Compressor type		Twin Rotary DCInv.+ Scroll CS	Twin Rotary DCInv.+ Scroll CS
Refrigerant type		R410A	R410A
Liquid pipe diameter	mm(inch")	12,70(1/2")	12,70(1/2")
Gas pipe diameter (suction)	mm(inch")	25,40(1")	28,58(1-1/8")
Gas pipe diameter (discharge)	mm(inch")	22,22(7/8")	22,22(7/8")
Balance pipe	mm(inch")	6,35(1/4")	6,35(1/4")
Max. pipe length	m	300	300
Gas standard charge	Kg	15	15
Operating limits (cooling/heating)	°C	-10 ~ +43 / -20 ~ +15	-10 ~ +43 / -20 ~ +15
Capacity ratio of indoor unit to outdoor unit	%	50 - 130	50 - 130
Connectable indoor units	no.	23	26
Max. height between units (Outdoor on top)	m	50	50
Max. height between units (Indoor on top)	m	40	40
Net weight Outdoor	Kg	350	350
Net dimension Outdoor (H./W./D.)	mm	1.887x890x890(+60)	1.887x890x890(+60)

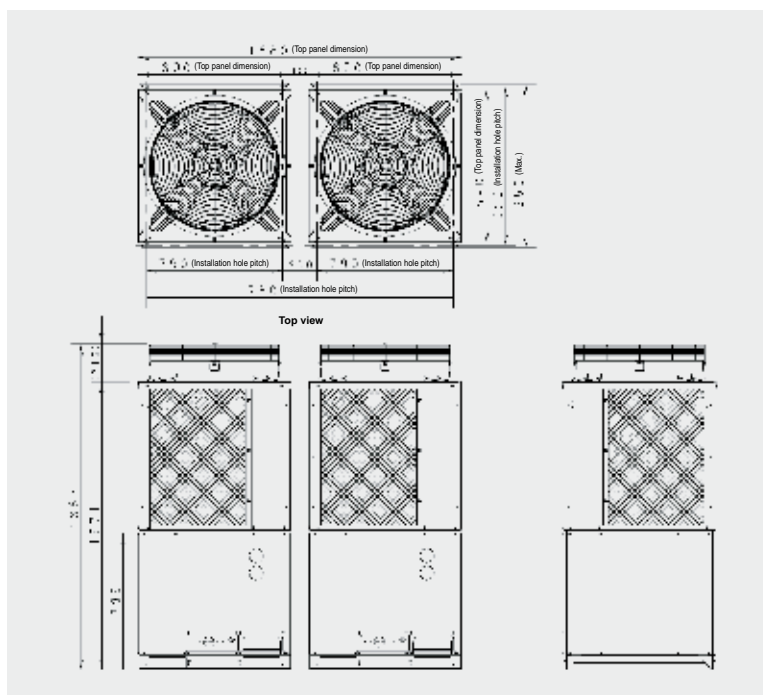

OUTDOOR UNITS MATCHINGS - TECHNICAL DATA

CAPACITY CLASSES (HP)		18 HP	20 HP	22 HP	24 HP
Outdoor units matchings		AES 10+08 MI3H	AES 10+10 MI3H	AES 12+10 MI3H	AES 14+10 MI3H
	Units				
Cooling/Heating capacity	kW	50,40 / 56,50	56,00 / 63,00	61,50 / 69,00	68,00 / 76,50
E.E.R. / C.O.P.	(kW/kW)	3,57 / 4,01	3,46 / 3,96	3,44 / 3,88	3,45 / 3,92
Air flowrate (h.)	m ³ /h	9.600 + 9.000	9.600 x 2	10.800 + 9.600	12.000 + 9.600
Sound pressure (normal/silent mode)	dB(A)	58 / 55	58 / 55	58,5 / 55,5	58 / 55
Sound power (normal mode)	dB(A)	69	69	69,5	72,5
Power supply	V/Ph/Hz	400/3N/50	400/3N/50	400/3N/50	400/3N/50
Power input (cooling/heating)	kW	14,1 / 14,1	16,2 / 15,9	17,9 / 17,8	19,7 / 19,5
Running current (cooling/heating)	A	22,6 / 22,6	26,0 / 25,5	28,7 / 28,5	31,9 / 31,6
Compressor type		Twin Rotary+Scroll	Twin Rotary+Scroll	Twin Rotary+Scroll	Twin Rotary+Scroll
Refrigerant control		Electr. Exp. Valve	Electr. Exp. Valve	Electr. Exp. Valve	Electr. Exp. Valve
Refrigerant type		R410A	R410A	R410A	R410A
Liquid pipe diameter after 1° distributor kit	mm(inch")	15,88(5/8")	15,88(5/8")	15,88(5/8")	15,88(5/8")
Gas pipe diameter after 1° distributor kit	mm(inch")	28,58(1-1/8")	28,58(1-1/8")	28,58(1-1/8")	28,58(1-1/8")
Discharge pipe diameter after 1° distributor kit	mm(inch")	22,22(7/8")	22,22(7/8")	25,4(1")	25,4(1")
Diameter of balancing pipe	mm(inch")	9,52(3/8")	9,52(3/8")	9,52(3/8")	9,52(3/8")
Max. pipe lenght	m	300	300	300	300
Gas standard charge	Kg	12,0 x 2	12,0 x 2	12,0 x 2	13,0 + 12,0
Operating limits (cooling/heating)	°C	-10 ~ +43 / -20 ~ +15	-10 ~ +43 / -20 ~ +15	-10 ~ +43 / -20 ~ +15	-10 ~ +43 / -20 ~ +15
Capacity ratio of indoor unit to outdoor unit	%	50 - 130	50 - 130	50 - 130	50 - 130
Connectable indoor units	N°	29	33	36	40
Net weight Outdoor	Kg	295 + 245	295 x 2	295 x 2	345 + 295
Net dimension Outdoor (H./W./D.)	mm	1.887x1.880x890(+60)	1.887x1.880x890(+60)	1.887x1.880x890(+60)	1.887x1.880x890(+60)

CAPACITY CLASSES (HP)		26 HP	28 HP	30 HP	32 HP
Outdoor units matchings		AES 16+10 MI3H	AES 16+12 MI3H	AES 16+14 MI3H	AES 16+16 MI3H
	Units				
Cooling/Heating capacity	kW	73,00 / 81,50	78,50 / 87,50	85,00 / 95,00	90,00 / 100,00
E.E.R. / C.O.P.	(kW/kW)	3,41 / 3,84	3,40 / 3,80	3,41 / 3,85	3,38 / 3,79
Air flowrate (h.)	m ³ /h	13.200 + 9.600	13.200 + 10.800	13.200 + 12.000	13.200 x 2
Sound pressure (normal/silent mode)	dB(A)	60 / 57	60,5 / 57,5	61 / 58	61,5 / 58,5
Sound power (normal mode)	dB(A)	73	73,5	74,5	75
Power supply	V/Ph/Hz	400/3N/50	400/3N/50	400/3N/50	400/3N/50
Power input (cooling/heating)	kW	21,4 / 21,2	23,1 / 23,0	24,9 / 24,7	26,6 / 26,4
Running current (cooling/heating)	A	34,7 / 34,4	37,5 / 37,3	40,8 / 40,5	43,6 / 43,3
Compressor type		Twin Rotary+Scroll	Twin Rotary+Scroll	Twin Rotary+Scroll	Twin Rotary+Scroll
Refrigerant control		Electr. Exp. Valve	Electr. Exp. Valve	Electr. Exp. Valve	Electr. Exp. Valve
Refrigerant type		R410A	R410A	R410A	R410A
Liquid pipe diameter after 1° distributor kit	mm(inch")	19,05(3/4")	19,05(3/4")	19,05(3/4")	19,05(3/4")
Gas pipe diameter after 1° distributor kit	mm(inch")	28,58(1-1/8")	1-3/8"	1-3/8"	1-3/8"
Discharge pipe diameter after 1° distributor kit	mm(inch")	25,4(1")	28,58(1-1/8")	28,58(1-1/8")	28,58(1-1/8")
Diameter of balancing pipe	mm(inch")	9,52(3/8")	9,52(3/8")	9,52(3/8")	9,52(3/8")
Max. pipe lenght	m	300	300	300	300
Gas standard charge	Kg	15,0 + 12,0	15,0 + 12,0	13,0 x 2	15,0 x 2
Operating limits (cooling/heating)	°C	-10 ~ +43 / -20 ~ +15	-10 ~ +43 / -20 ~ +15	-10 ~ +43 / -20 ~ +15	-10 ~ +43 / -20 ~ +15
Capacity ratio of indoor unit to outdoor unit	%	50 - 130	50 - 130	50 - 130	50 - 130
Connectable indoor units	N°	40	40	40	40
Net weight Outdoor	Kg	640	640	700	700
Net dimension Outdoor (H./W./D.)	mm	1.887x1.880x890(+60)	1.887x1.880x890(+60)	1.887x1.880x890(+60)	1.887x1.880x890(+60)

OUTDOOR UNITS MATCHINGS - TECHNICAL DATA

CAPACITY CLASSES (HP)		34 HP	36 HP	38 HP	40 HP
Outdoor units matchings		AES 14+10+10 MI3H	AES 16+10+10 MI3H	AES 16+12+10 MI3H	AES 14+14+10 MI3H
	Units				
Cooling/Heating capacity	kW	96,00 / 108,00	101,00 / 113,00	107,00 / 119,00	113,00 / 127,00
E.E.R. / C.O.P.	(kW/kW)	3,45 / 3,93	3,41 / 3,88	3,42 / 3,84	3,42 / 3,88
Air flowrate (h.)	m³/h	12.000 + 9.600 x 2	13.200 + 9.600 x 2	13.200 + 10.800 + 9.600	13.200 + 12.000 + 9.600
Sound pressure (normal/silent mode)	dB(A)	61 / 58	61,5 / 58,5	61,5 / 58,5	62 / 59
Sound power (normal mode)	dB(A)	73,5	74	74	75,5
Power supply	V/Ph/Hz	400/3N/50	400/3N/50	400/3N/50	400/3N/50
Power input (cooling/heating)	kW	27,8 / 27,5	29,1 / 28,7	31,3 / 31,0	33,0 / 32,7
Running current (cooling/heating)	A	45,1 / 44,6	48,0 / 47,2	51,0 / 50,0	54,0 / 54,0
Compressor type		Twin Rotary+Scroll	Twin Rotary+Scroll	Twin Rotary+Scroll	Twin Rotary+Scroll
Refrigerant control		Electr. Exp. Valve	Electr. Exp. Valve	Electr. Exp. Valve	Electr. Exp. Valve
Refrigerant type		R410A	R410A	R410A	R410A
Liquid pipe diameter after 1° distributor kit	mm(inch")	19,05(3/4")	19,05(3/4")	19,05(3/4")	19,05(3/4")
Gas pipe diameter after 1° distributor kit	mm(inch")	1-3/8"	1-5/8"	1-5/8"	1-5/8"
Discharge pipe diameter after 1° distributor kit	mm(inch")	28,58(1-1/8")	28,58(1-1/8")	1-3/8"	1-3/8"
Diameter of balancing pipe	mm(inch")	9,52(3/8")	9,52(3/8")	9,52(3/8")	9,52(3/8")
Max. pipe lenght	m	300	300	300	300
Gas standard charge	Kg	15,0+12,0 x 2	15,0+12,0 x 2	15,0+12,0 x 2	15,0 x 2+12,0
Operating limits (cooling/heating)	°C	-10 ~ +43 / -20 ~ +15	-10 ~ +43 / -20 ~ +15	-10 ~ +43 / -20 ~ +15	-10 ~ +43 / -20 ~ +15
Capacity ratio of indoor unit to outdoor unit	%	50 - 130	50 - 130	50 - 130	50 - 130
Connectable indoor units	N°	40	40	40	40
Net weight Outdoor	Kg	930	930	930	990
Net dimension Outdoor (H./W./D.)	mm	1.887x2.870x890(+60)	1.887x2.870x890(+60)	1.887x2.870x890(+60)	1.887x2.870x890(+60)

CAPACITY CLASSES (HP)		42 HP	44 HP	46 HP	48 HP
Outdoor units matchings		AES 16+16+10 MI3H	AES 16+16+12 MI3H	AES 16+16+14 MI3H	AES 16+16+16 MI3H
	Units				
Cooling/Heating capacity	kW	118,00 / 132,00	124,00 / 138,00	130,00 / 145,00	135,00 / 150,00
E.E.R. / C.O.P.	(kW/kW)	3,40 / 3,84	3,41 / 3,81	3,40 / 3,83	3,38 / 3,79
Air flowrate (h.)	m³/h	13.200 x 2 + 9.600	13.200 x 2 + 10.800	13.200 x 2 + 12.000	13.200 x 3
Sound pressure (normal/silent mode)	dB(A)	62,5 / 59,5	62,5 / 59,5	63 / 60	63 / 60
Sound power (normal mode)	dB(A)	75,5	76	76,5	77
Power supply	V/Ph/Hz	400/3N/50	400/3N/50	400/3N/50	400/3N/50
Power input (cooling/heating)	kW	34,7 / 34,4	36,4 / 36,2	38,2 / 37,9	39,9 / 39,6
Running current (cooling/heating)	A	57,0 / 56,0	60,0 / 59,0	63,0 / 62,0	65,0 / 65,0
Compressor type		Twin Rotary+Scroll	Twin Rotary+Scroll	Twin Rotary+Scroll	Twin Rotary+Scroll
Refrigerant control		Electr. Exp. Valve	Electr. Exp. Valve	Electr. Exp. Valve	Electr. Exp. Valve
Refrigerant type		R410A	R410A	R410A	R410A
Liquid pipe diameter after 1° distributor kit	mm(inch")	19,05(3/4")	19,05(3/4")	19,05(3/4")	19,05(3/4")
Gas pipe diameter after 1° distributor kit	mm(inch")	1-5/8"	1-5/8"	1-5/8"	1-5/8"
Discharge pipe diameter after 1° distributor kit	mm(inch")	1-3/8"	1-3/8"	1-3/8"	1-3/8"
Diameter of balancing pipe	mm(inch")	9,52(3/8")	9,52(3/8")	9,52(3/8")	9,52(3/8")
Max. pipe lenght	m	300	300	300	300
Gas standard charge	Kg	15,0 x 2+12,0	15,0 x 2+12,0	15,0 x 3	15,0 x 3
Operating limits (cooling/heating)	°C	-10 ~ +43 / -20 ~ +15	-10 ~ +43 / -20 ~ +15	-10 ~ +43 / -20 ~ +15	-10 ~ +43 / -20 ~ +15
Capacity ratio of indoor unit to outdoor unit	%	50 - 130	50 - 130	50 - 130	50 - 130
Connectable indoor units	N°	40	40	40	40
Net weight Outdoor	Kg	990	990	1050	1050
Net dimension Outdoor (H./W./D.)	mm	1.887x2.870x890(+60)	1.887x2.870x890(+60)	1.887x2.870x890(+60)	1.887x2.870x890(+60)

CONTROL SYSTEMS / DIMENSIONS

● Standard wired remote controller

● Schedule timer

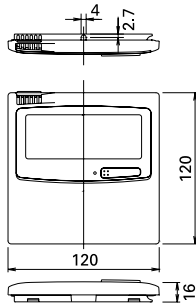

● Wireless remote controller

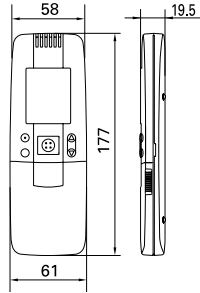

● Separate receiver for wireless remote controller

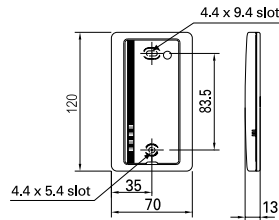

● Simplified remote controller

● Remote sensor

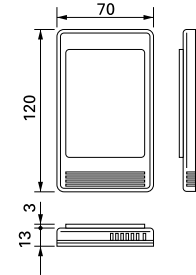

● System controller

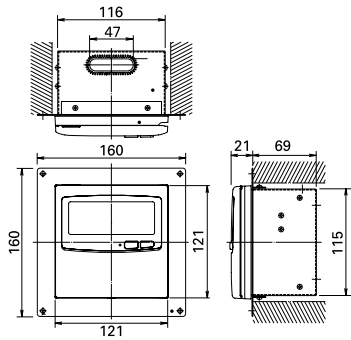

● Intelligent controller

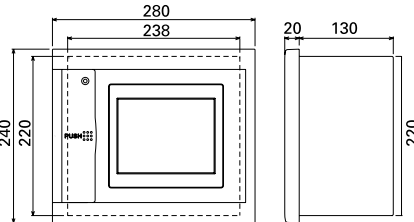

● Communication adapter

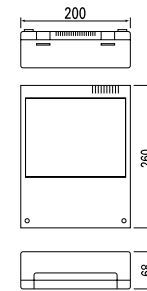

● ON/OFF controller

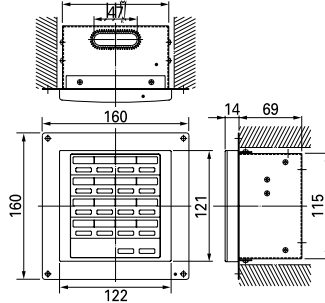

● LonWorks interface

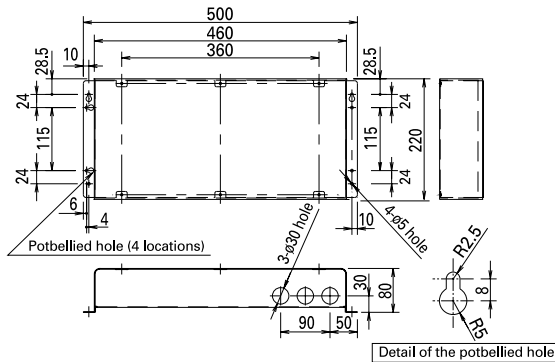

● Seri-Para I/O unit for outdoor unit

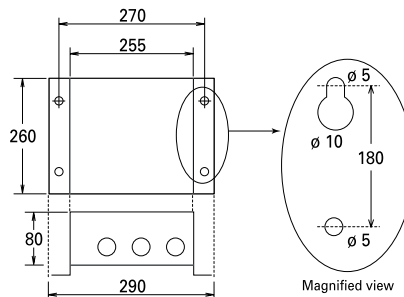

DISTRIBUTION JOINT KITS FOR 2-WAY SYSTEMS

Position	part A	part B	part C	part D	part E	part F	part G	part H	part I	part J
Dimension	38.1(1-1/2")	31.75(1-1/4")	28.58(1-1/8")	25.4(1")	22.22(7/8")	19.05(3/4")	15.88(5/8")	12.7(1/2")	9.52(3/8")	6.35(1/4")

●DDVI16

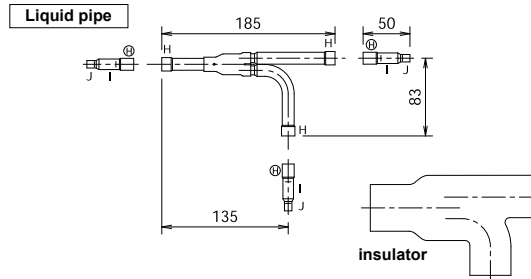
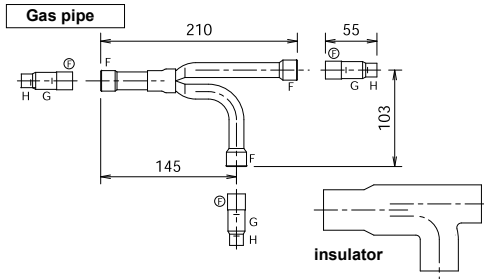

●DDVI68

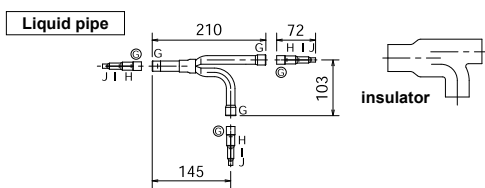
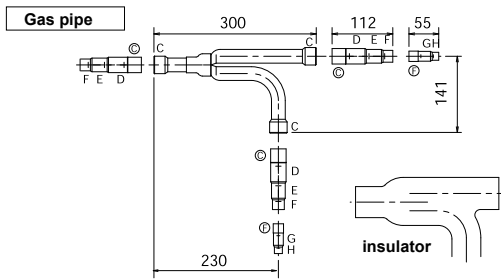

●DDVI135

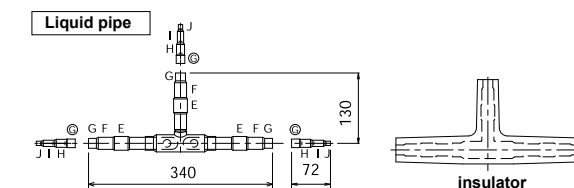
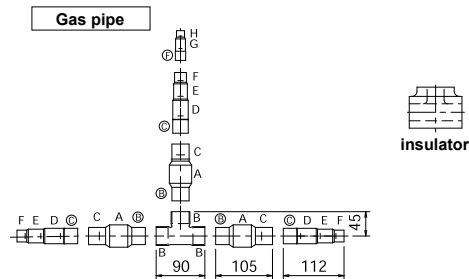

●DDVE68

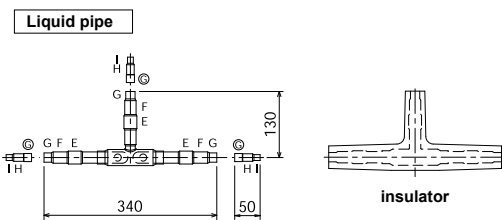
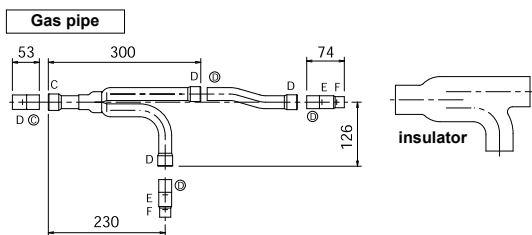

●DDVE135

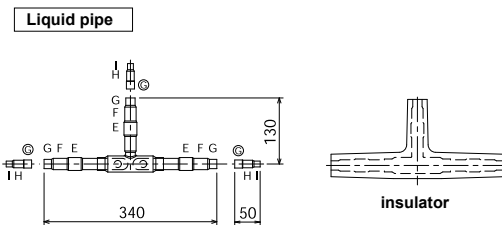
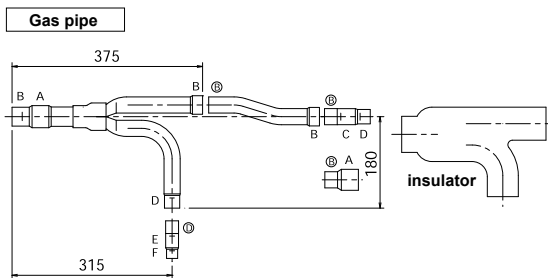

LEGENDA :

- F letter in circle = female side
- F letter not in circle = male side

SOLENOID VALVE KITS FOR 3-WAY SYSTEMS

M3 EEV 22-56B (for 22-56 models of indoor units)

It is possible to connect 1 only solenoid valve kit controlling a group of indoor units, with a total capacity up to 5,6 kW.

All the indoor units of the group will operate in the same mode (cooling or heating)

M3 EEV 73-140B (for 73-140 models of indoor units)

It is possible to connect 1 only solenoid valve kit controlling a group of indoor units, with a total capacity up to 14 kW.

All the indoor units of the group will operate in the same mode (cooling or heating)

In case 1 only solenoid valve kit is used to control a group of indoor units, only 1 control must be used for the whole group



SOLENOID VALVE CONTROLLER

M3 EEVC (B)



DISTRIBUTION JOINT KITS FOR 3-WAY SYSTEMS

Position	Part A	Part B	Part C	Part D	Part E	Part F	Part G	Part H	Part I	Part J
Dimension	38.1	31.75	28.58	25.4	22.22	19.05	15.88	12.7	9.52	6.35

●M3DDV22

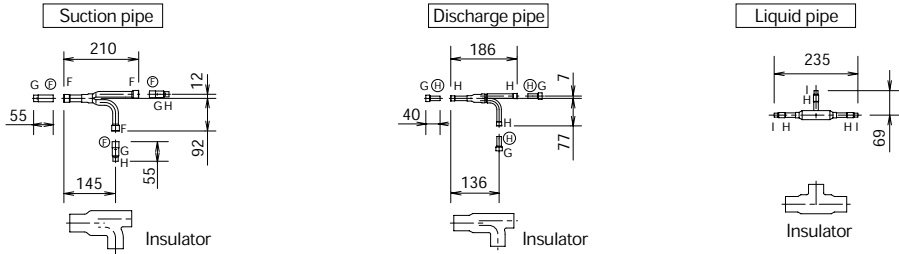

●M3DDV68

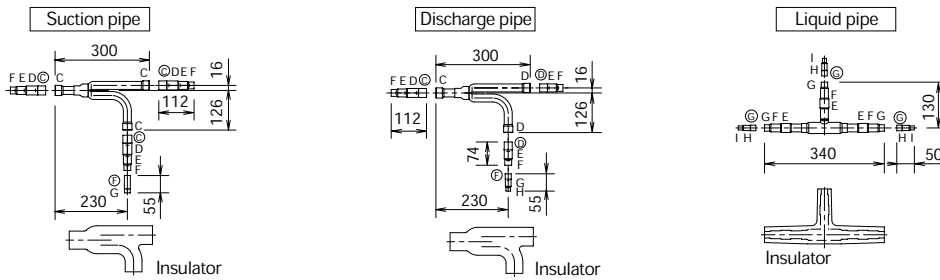

●M3DDV135

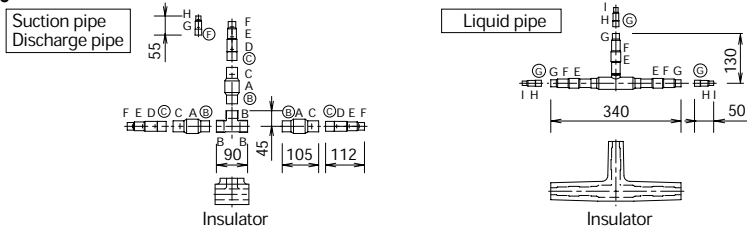

●M3DDVE68

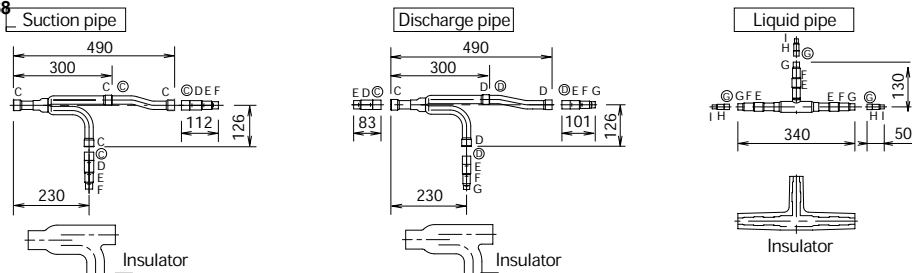

●M3DDVE135

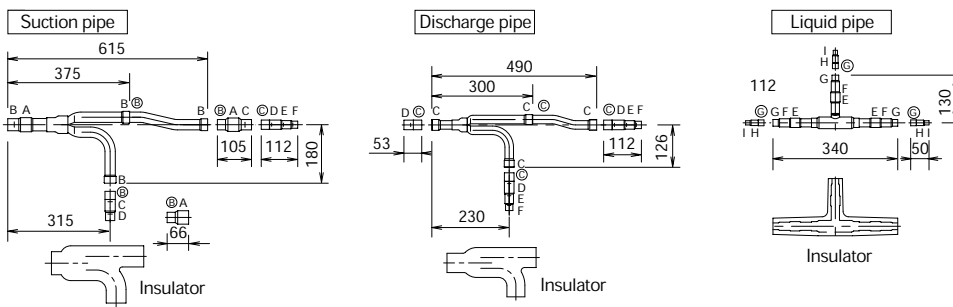

LEGENDA :

- F letter in circle = female side
- F letter not in circle = male side



AWF 22-28-36



AWS 56-73

AWF 22-28-36 / AWS 56-73

- High wall indoor unit for Mini Multiset and Multiset V.R.F. DC Inverter systems
- New flat panel unit for 2,2 – 2,8 and 3,6 kW models: compact and elegant with its white pearl coloured panel, this new unit can be easily integrated in every type of furniture
- Automatic change-over between cooling and heating modes
- Special function during heat pump start-up and defrosting cycle to avoid cool air emission in the room
- Night set back capability
- To be managed by the wired and wireless controllers of the Multiset V.R.F. DC Inverter systems (all optional)
- “I Feel” feature and temperature sensor inside the remote control
- Dry function
- New three-speed tangential fan by remote control, granting a better and low noise air diffusion
- Horizontal flap swinging or to be set to a fixed position by remote control
- Vertical flap by manual control
- Washable air filter
- Three-way condensate discharge (right, central and left)
- Dynamic refrigerant control by DC Inverter compressor and circuit, electronic valve and fuzzy logic managed by a powerful microprocessor

TECHNICAL DATA

PRODUCT NAME		AWF22MH		AWF28MH		AWF36MH	
Features	Units	Cooling	Heating	Cooling	Heating	Cooling	Heating
Cooling/Heating capacity	kW	2,20	2,50	2,80	3,20	3,60	4,20
	BTU/h	7.500	8.520	9.550	10.920	12.280	14.320
	kcal/h	1.890	2.150	2.410	2.750	3.100	3.610
Air flowrate Indoor (h.m.l.)	m ³ /h	540-450-360		540-450-360		600-510-390	
Dehumidification	l/h	1,3		1,6		2,0	
Fan speeds	n°	3 + Auto		3 + Auto		3 + Auto	
Sound pressure Indoor (h.m.l.)	dB(A)	35-32-28		35-32-28		37-33-29	
Sound power Indoor (h.m.l.)	dB(A)	46-43-39		46-43-39		48-44-40	
Power supply	V/Ph/Hz	230/1/50		230/1/50		230/1/50	
Running consumption	kW	0,037	0,038	0,037	0,038	0,043	0,044
Refrigerant type		R410A		R410A		R410A	
Liquid pipe diameter	mm(inch")	6,35(1/4")		6,35(1/4")		6,35(1/4")	
Gas pipe diameter	mm(inch")	12,70(1/2")		12,70(1/2")		12,70(1/2")	
Net weight Indoor	Kg	10,0		10,0		10,0	
Net dimension Indoor (H./W./D.)	mm	285x825x217		285x825x217		285x825x217	

PRODUCT NAME		AWS56MH		AWS73MH	
Features	Units	Cooling	Heating	Cooling	Heating
Cooling/Heating capacity	kW	5,60	6,30	7,30	8,00
	BTU/h	19.100	21.480	24.890	27.280
	kcal/h	4.820	5.420	6.280	6.880
Air flowrate Indoor (h.m.l.)	m ³ /h	720-600-480		960-840-600	
Dehumidification	l/h	2,3		4,0	
Fan speeds	n°	3 + Auto		3 + Auto	
Sound pressure Indoor (h.m.l.)	dB(A)	36-32-28		42-38-35	
Sound power Indoor (h.m.l.)	dB(A)	47-33-39		53-49-46	
Power supply	V/Ph/Hz	230/1/50		230/1/50	
Running consumption	kW	0,033	0,033	0,052	0,052
Refrigerant type		R410A		R410A	
Liquid pipe diameter	mm(inch")	6,35(1/4")		9,52(3/8")	
Gas pipe diameter	mm(inch")	12,70(1/2")		15,88(5/8")	
Net weight Indoor	Kg	14		21	
Net dimension Indoor (H./W./D.)	mm	285x995x203		330x1.140x228	

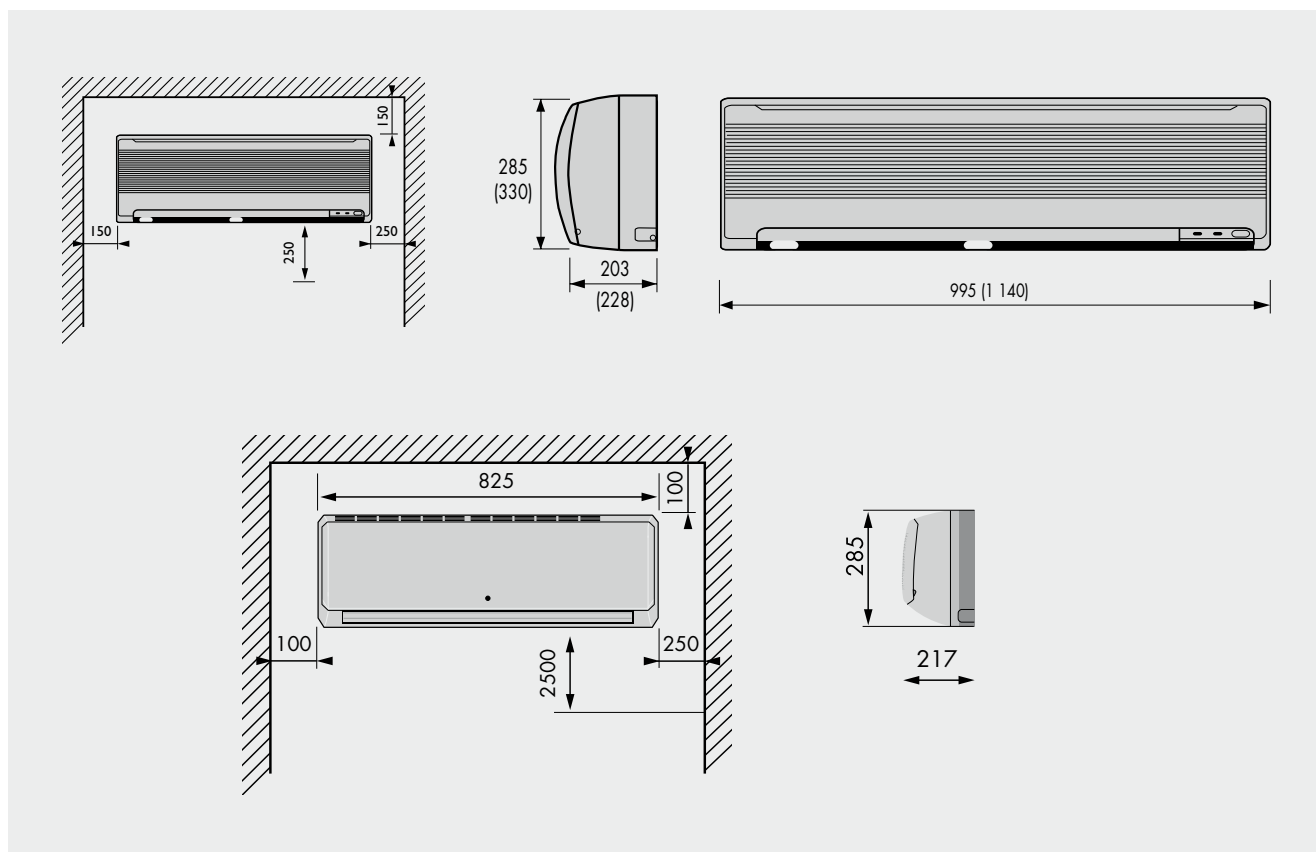



ASS 22-28-36-45-56

- Four-way cassette indoor unit to be matched with Mini Multiset and Multiset V.R.F. DC Inverter systems
- Automatic change-over between cooling and heating modes
- Special function during heat pump start-up and defrosting cycle to avoid cool air emission in the room
- Night set back capability
- To be managed by the wired and wireless controllers of the Multiset V.R.F. DC Inverter systems (all optional)
- "I Feel" feature and temperature sensor inside the remote control
- Dry function
- New three-speed centrifugal fan by remote control, granting a better and low noise air diffusion
- Horizontal flap swinging or to be set on a fixed position by remote control
- Washable air filter
- Integrated pump for condensate discharge
- Special anti-dripping system on the four air outlets
- Dynamic refrigerant control by DC Inverter compressor and circuit, electronic valve and fuzzy logic managed by a powerful microprocessor

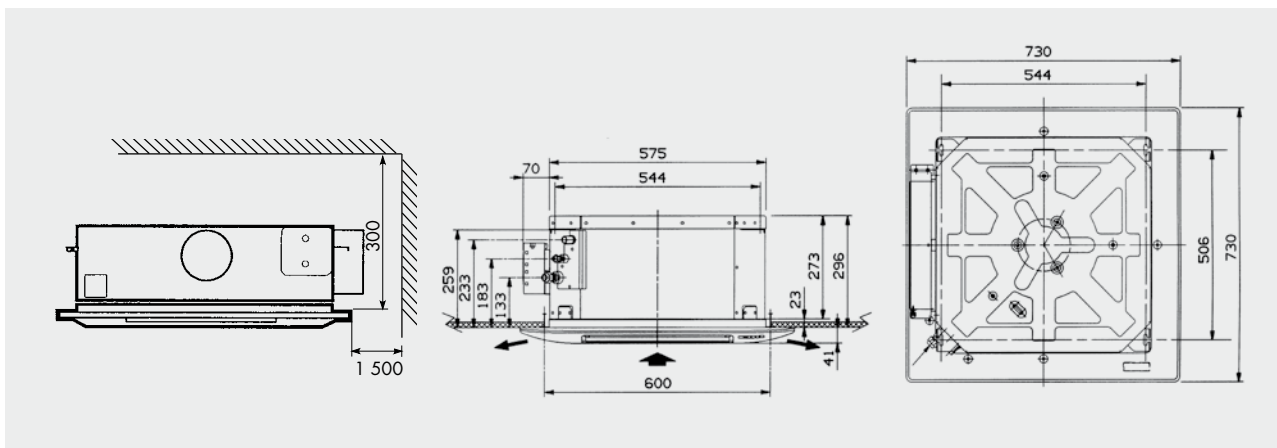

TECHNICAL DATA

PRODUCT NAME		ASS22MH		ASS28MH	
Features	Units	Cooling	Heating	Cooling	Heating
	kW	2,20	2,50	2,80	3,20
Cooling/Heating capacity	BTU/h	7.500	8.520	9.550	10.920
	kcal/h	1.890	2.150	2.410	2.750
Air flowrate Indoor (h.m.l.)	m ³ /h	700-600-500		700-600-500	
Dehumidification	l/h	0,9		1,0	
Fan speeds	n°	3 + Auto		3 + Auto	
Sound pressure Indoor (h.m.l.) at 2 m	dB(A)	43-40-37		43-40-37	
Sound power Indoor (h.m.l.)	dB(A)	52-49-46		52-49-46	
Power supply	V/Ph/Hz	230/1/50		230/1/50	
Running consumption	kW	0,087	0,087	0,087	0,087
Refrigerant type		R410A		R410A	
Liquid pipe diameter	mm(inch")	6,35(1/4")		6,35(1/4")	
Gas pipe diameter	mm(inch")	12,70(1/2")		12,70(1/2")	
Net weight Indoor / grille	Kg	16/2,5		16/2,5	
Net dimension Indoor (H./W./D.)	mm	296x575x575		296x575x575	
Net dimension grille (H./W./D.)	mm	41x730x730		41x730x730	

PRODUCT NAME		ASS36MH		ASS45MH	
Features	Units	Cooling	Heating	Cooling	Heating
	kW	3,60	4,20	4,70	5,20
Cooling/Heating capacity	BTU/h	12.280	14.320	16.020	17.740
	kcal/h	3.100	3.610	4.040	4.470
Air flowrate Indoor (h.m.l.)	m ³ /h	700-600-500		750-630-530	
Dehumidification	l/h	1,2		2,3	
Fan speeds	n°	3 + Auto		3 + Auto	
Sound pressure Indoor (h.m.l.) at 2 m	dB(A)	43-40-37		44-40-37	
Sound power Indoor (h.m.l.)	dB(A)	52-49-46		53-49-46	
Power supply	V/Ph/Hz	230/1/50		230/1/50	
Running consumption	kW	0,087	0,087	0,087	0,087
Refrigerant type		R410A		R410A	
Liquid pipe diameter	mm(inch")	6,35(1/4")		6,35(1/4")	
Gas pipe diameter	mm(inch")	12,70(1/2")		12,70(1/2")	
Net weight Indoor / grille	Kg	16/2,5		18/2,5	
Net dimension Indoor (H./W./D.)	mm	296x575x575		296x575x575	
Net dimension grille (H./W./D.)	mm	41x730x730		41x730x730	

PRODUCT NAME		ASS56MH	
Features	Units	Cooling	Heating
	kW	5,60	6,30
Cooling/Heating capacity	BTU/h	19.100	21.480
	kcal/h	4.820	5.420
Air flowrate Indoor (h.m.l.)	m ³ /h	750-630-530	
Dehumidification	l/h	2,3	
Fan speeds	n°	3 + Auto	
Sound pressure Indoor (h.m.l.) at 2 m	dB(A)	44-40-37	
Sound power Indoor (h.m.l.)	dB(A)	53-49-46	
Power supply	V/Ph/Hz	230/1/50	
Running consumption	kW	0,087	0,087
Refrigerant type		R410A	
Liquid pipe diameter	mm(inch")	6,35(1/4")	
Gas pipe diameter	mm(inch")	12,70(1/2")	
Net weight Indoor / grille	Kg	18/2,5	
Net dimension Indoor (H./W./D.)	mm	296x575x575	
Net dimension grille (H./W./D.)	mm	41x730x730	

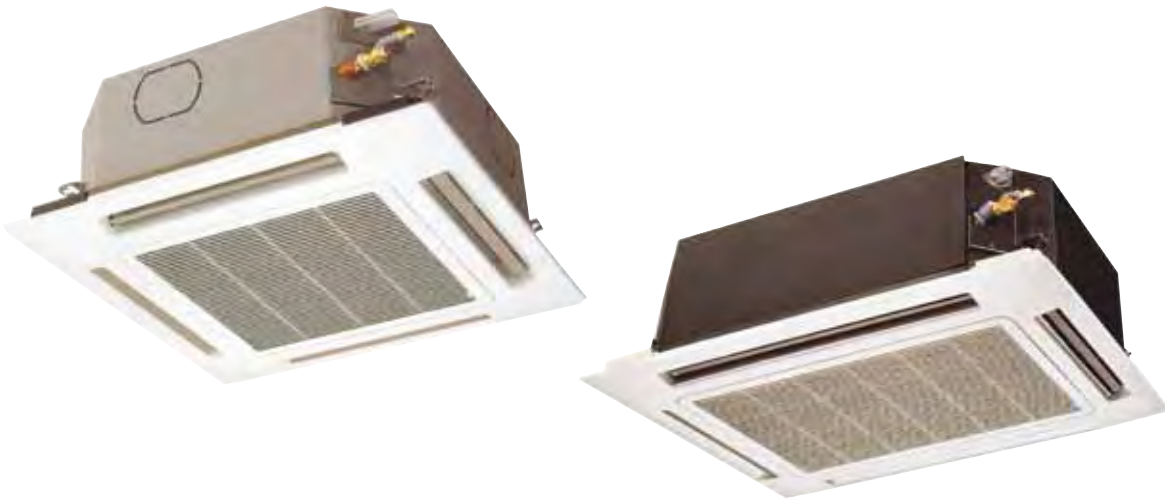

ASS 73-106-140

- Four-way cassette indoor unit to be matched with Mini Multiset and Multiset V.R.F. DC Inverter systems
- Automatic change-over between cooling and heating modes
- Special function during heat pump start-up and defrosting cycle to avoid cool air emission in the room
- Night set back capability
- To be managed by the wired and wireless controllers of the Multiset V.R.F. DC Inverter systems (all optional)
- “I Feel” feature and temperature sensor inside the remote control
- Dry function
- New three-speed centrifugal fan by remote control, granting a better and low noise air diffusion
- Horizontal flap swinging or to be set on a fixed position by remote control
- Special system to avoid condensate dripping from air outlet ribs
- Washable air filter
- Integrated pump for condensate discharge
- Special anti-dripping system on the four air outlets
- Dynamic refrigerant control by DC Inverter compressor and circuit, electronic valve and fuzzy logic managed by a powerful microprocessor

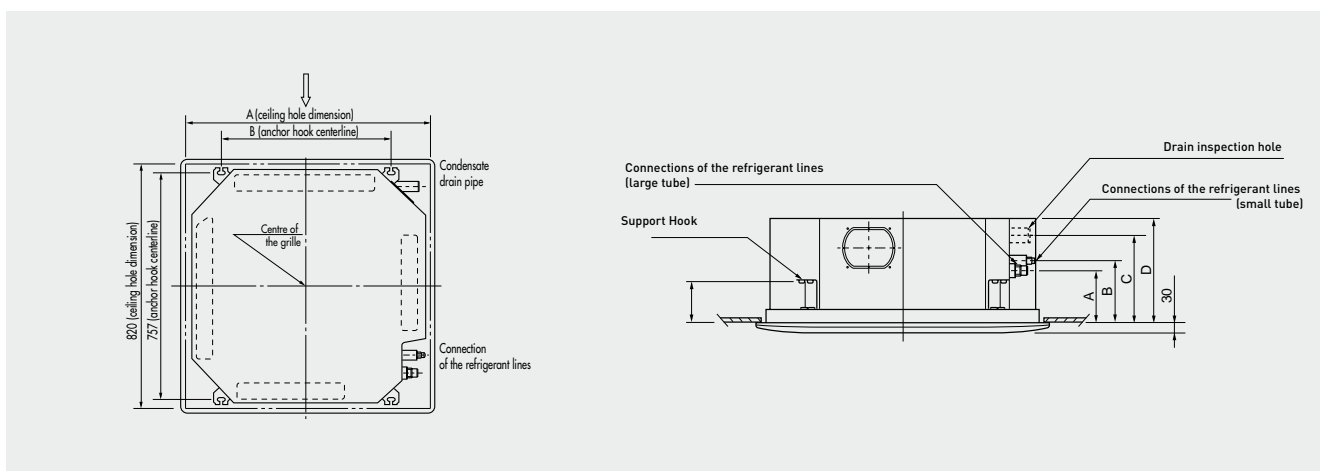

TECHNICAL DATA

PRODUCT NAME		ASS73MH	
Features	Units	Cooling	Heating
	kW	7,30	8,00
Cooling/Heating capacity	BTU/h	24.890	27.280
	kcal/h	6.280	6.880
Air flowrate Indoor (h.m.l.)	m ³ /h	1.140-1.020-840	
Dehumidification	l/h	3,6	
Fan speeds	n°	3 + Auto	
Sound pressure Indoor (h.m.l.) at 2 m	dB(A)	47-45-41	
Sound power Indoor (h.m.l.)	dB(A)	56-54-50	
Power supply	V/Ph/Hz	230/1/50	
Running consumption	kW	0,175	0,120
Refrigerant type		R410A	
Liquid pipe diameter	mm(inch")	9,52(3/8")	
Gas pipe diameter	mm(inch")	15,88(5/8")	
Net weight Indoor / grille	Kg	22/6	
Net dimension Indoor (H./W./D.)	mm	338x860x860	
Net dimension grille (H./W./D.)	mm	30x860x860	

PRODUCT NAME		ASS106MH	
Features	Units	Cooling	Heating
	kW	10,60	11,40
Cooling/Heating capacity	BTU/h	36.150	38.880
	kcal/h	9.120	9.800
Air flowrate Indoor (h.m.l.)	m ³ /h	1.920-1.680-1.320	
Dehumidification	l/h	4,6	
Fan speeds	n°	3 + Auto	
Sound pressure Indoor (h.m.l.) at 2 m	dB(A)	53-50-46	
Sound power Indoor (h.m.l.)	dB(A)	62-59-55	
Power supply	V/Ph/Hz	230/1/50	
Running consumption	kW	0,210	0,150
Refrigerant type		R410A	
Liquid pipe diameter	mm(inch")	9,52(3/8")	
Gas pipe diameter	mm(inch")	15,88(5/8")	
Net weight Indoor / grille	Kg	27/8	
Net dimension Indoor (H./W./D.)	mm	338x1.150x860	
Net dimension grille (H./W./D.)	mm	30x1.150x860	

PRODUCT NAME		ASS140MH	
Features	Units	Cooling	Heating
	kW	14,00	16,00
Cooling/Heating capacity	BTU/h	47.740	54.560
	kcal/h	12.040	13.760
Air flowrate Indoor (h.m.l.)	m ³ /h	1.920-1.680-1.320	
Dehumidification	l/h	6,3	
Fan speeds	n°	3 + Auto	
Sound pressure Indoor (h.m.l.) at 2 m	dB(A)	53-50-46	
Sound power Indoor (h.m.l.)	dB(A)	62-59-55	
Power supply	V/Ph/Hz	230/1/50	
Running consumption	kW	0,210	0,150
Refrigerant type		R410A	
Liquid pipe diameter	mm(inch")	9,52(3/8")	
Gas pipe diameter	mm(inch")	15,88(5/8")	
Net weight Indoor / grille	Kg	27/8	
Net dimension Indoor (H./W./D.)	mm	338x1.150x860	
Net dimension grille (H./W./D.)	mm	30x1.150x860	

	A (mm)	B (mm)
ASS 73	820	566
ASS 106/140	1 110	856

	A (mm)	B (mm)	C (mm)	D (mm)	E (mm)	Weight (kg)
ASS 73	157	182	261	308	124	28
ASS 106/140	157	182	291	338	124	35

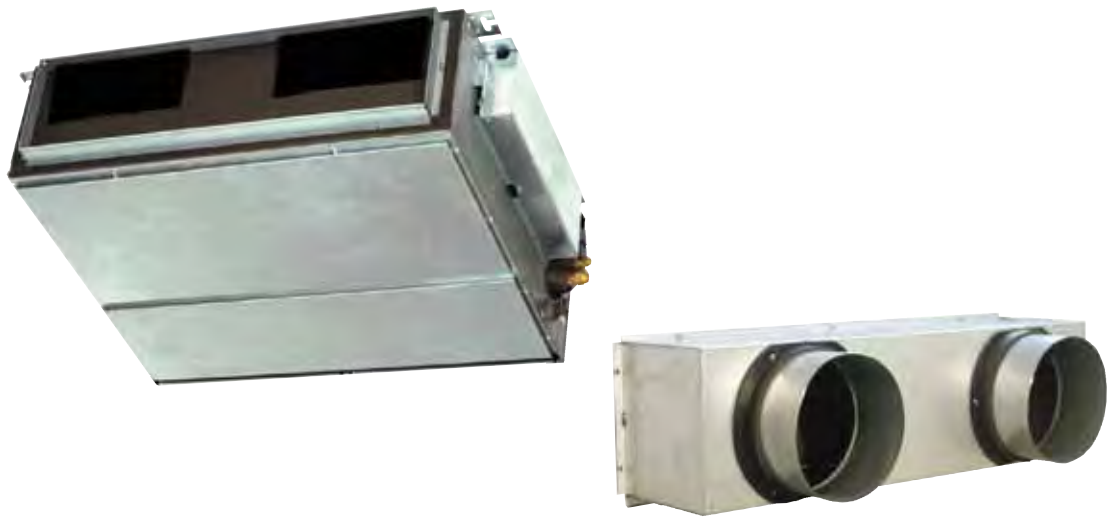

ADS 22-28-36

- Ducted indoor unit with optional two-way discharge plenum, to be matched with Mini Multiset and Multiset V.R.F. DC Inverter systems
- Automatic change-over between cooling and heating modes
- Special function during heat pump start-up and defrosting cycle to avoid cool air emission in the room
- Night set back capability
- To be managed by the wired and wireless controllers of the Multiset V.R.F. DC Inverter systems (all optional)
- "I Feel" feature and temperature sensor inside the remote control
- Dry function
- Three-speed centrifugal fan by remote control and feature to increase speed/pressure (from 5 to 7 mm W.C.)
- Washable air filter
- Integrated pump for condensate discharge
- Dynamic refrigerant control by DC Inverter compressor and circuit, electronic valve and fuzzy logic managed by a powerful microprocessor

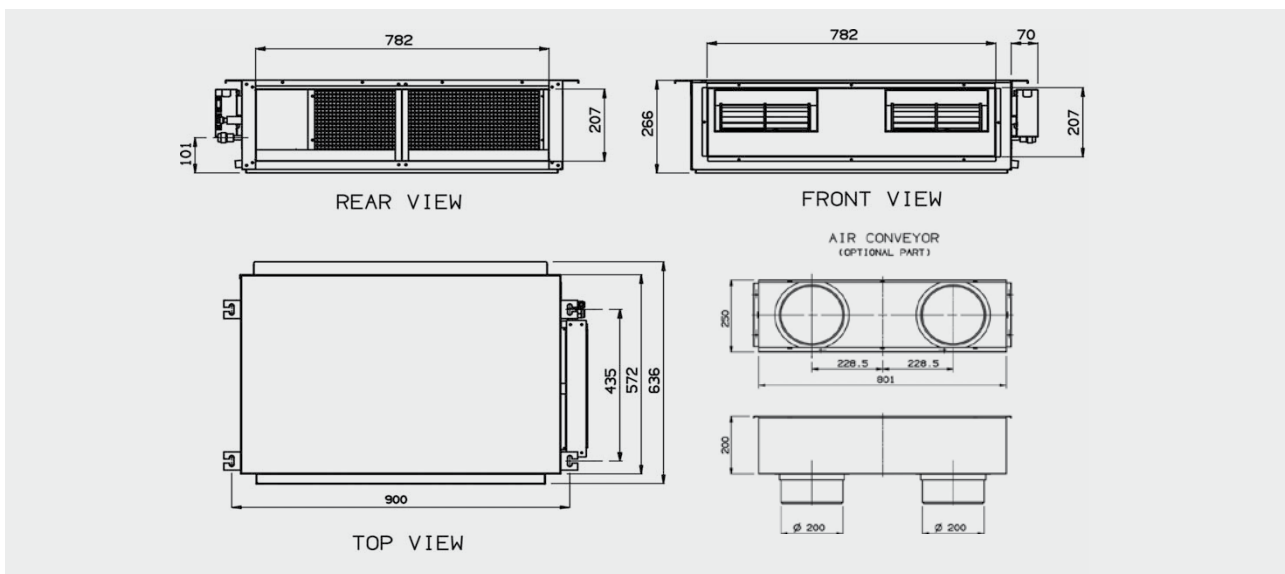

TECHNICAL DATA

PRODUCT NAME		ADS22MH	
Features	Units	Cooling	Heating
	kW	2,20	2,50
Cooling/Heating capacity	BTU/h	7.500	8.520
	kcal/h	1.890	2.150
Air flowrate Indoor (h.-m.-l.)	m ³ /h	600-510-440	
Dehumidification	l/h	0,8	
External static pressure (min-max)	mm W.G.	5-7	
Fan speeds	n°	3 + Auto	
Sound power Indoor (h.m.l.)	dB(A)	54-52-49	
Sound pressure Indoor (h.-m.-l.) at plenum connection	dB(A)	45-43-40	
Sound pressure Indoor at ducts exit	dB(A)	< 20	
Power supply	V/Ph/Hz	230/1/50	
Running consumption	kW	0,110	0,110
Refrigerant type		R410A	
Liquid pipe diameter	mm(inch")	6,35(1/4")	
Gas pipe diameter	mm(inch")	12,7(1/2")	
Duct diameter of the 2-way discharge plenum (optional)	mm	200	
Net weight Indoor	kg	30	
Net dimension Indoor (H./W./D.)	mm	266x926x571	
Net dimension Indoor with plenum (H./W./D.)	mm	266x926x771	

PRODUCT NAME		ADS28MH	
Features	Units	Cooling	Heating
	kW	2,80	3,20
Cooling/Heating capacity	BTU/h	9.550	10.920
	kcal/h	2.410	2.750
Air flowrate Indoor (h.-m.-l.)	m ³ /h	600-510-440	
Dehumidification	l/h	0,8	
External static pressure (min-max)	mm W.G.	5-7	
Fan speeds	n°	3 + Auto	
Sound power Indoor (h.m.l.)	dB(A)	54-52-49	
Sound pressure Indoor (h.-m.-l.) at plenum connection	dB(A)	45-43-40	
Sound pressure Indoor at ducts exit	dB(A)	< 20	
Power supply	V/Ph/Hz	230/1/50	
Running consumption	kW	0,110	0,110
Refrigerant type		R410A	
Liquid pipe diameter	mm(inch")	6,35(1/4")	
Gas pipe diameter	mm(inch")	12,7(1/2")	
Duct diameter of the 2-way discharge plenum (optional)	mm	200	
Net weight Indoor	kg	30	
Net dimension Indoor (H./W./D.)	mm	266x926x571	
Net dimension Indoor with plenum (H./W./D.)	mm	266x926x771	

PRODUCT NAME		ADS36MH	
Features	Units	Cooling	Heating
	kW	3,60	4,20
Cooling/Heating capacity	BTU/h	12.280	14.320
	kcal/h	3.100	3.610
Air flowrate Indoor (h.-m.-l.)	m ³ /h	600-510-440	
Dehumidification	l/h	1,5	
External static pressure (min-max)	mm W.G.	5-7	
Fan speeds	n°	3 + Auto	
Sound power Indoor (h.m.l.)	dB(A)	54-52-49	
Sound pressure Indoor (h.-m.-l.) at plenum connection	dB(A)	45-43-40	
Sound pressure Indoor at ducts exit	dB(A)	< 20	
Power supply	V/Ph/Hz	230/1/50	
Running consumption	kW	0,110	0,110
Refrigerant type		R410A	
Liquid pipe diameter	mm(inch")	6,35(1/4")	
Gas pipe diameter	mm(inch")	12,7(1/2")	
Duct diameter of the 2-way discharge plenum (optional)	mm	200	
Net weight Indoor	kg	30	
Net dimension Indoor (H./W./D.)	mm	266x926x571	
Net dimension Indoor with plenum (H./W./D.)	mm	266x926x771	

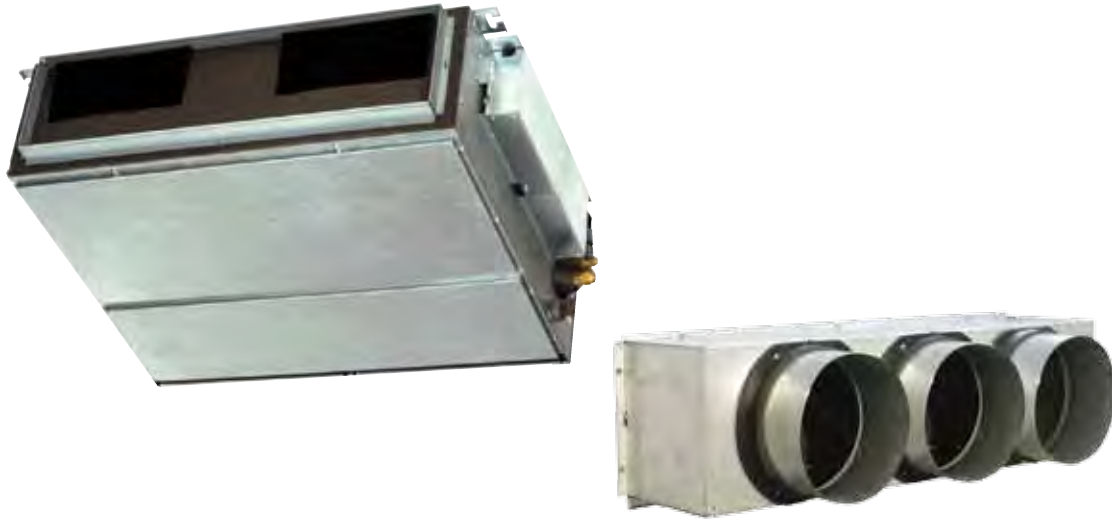

ADS 45-56-64

- Ducted indoor unit with optional three-way discharge plenum, to be matched with Mini Multiset and Multiset V.R.F. DC Inverter systems
- Automatic change-over between cooling and heating modes
- Special function during heat pump start-up and defrosting cycle to avoid cool air emission in the room
- Night set back capability
- To be managed by the wired and wireless controllers of the Multiset V.R.F. DC Inverter systems (all optional)
- "I Feel" feature and temperature sensor inside the remote control
- Dry function
- Three-speed centrifugal fan by remote control and feature to increase speed/pressure (from 5 to 7 mm W.C.)
- Washable air filter
- Integrated pump for condensate discharge
- Dynamic refrigerant control by DC Inverter compressor and circuit, electronic valve and fuzzy logic managed by a powerful microprocessor

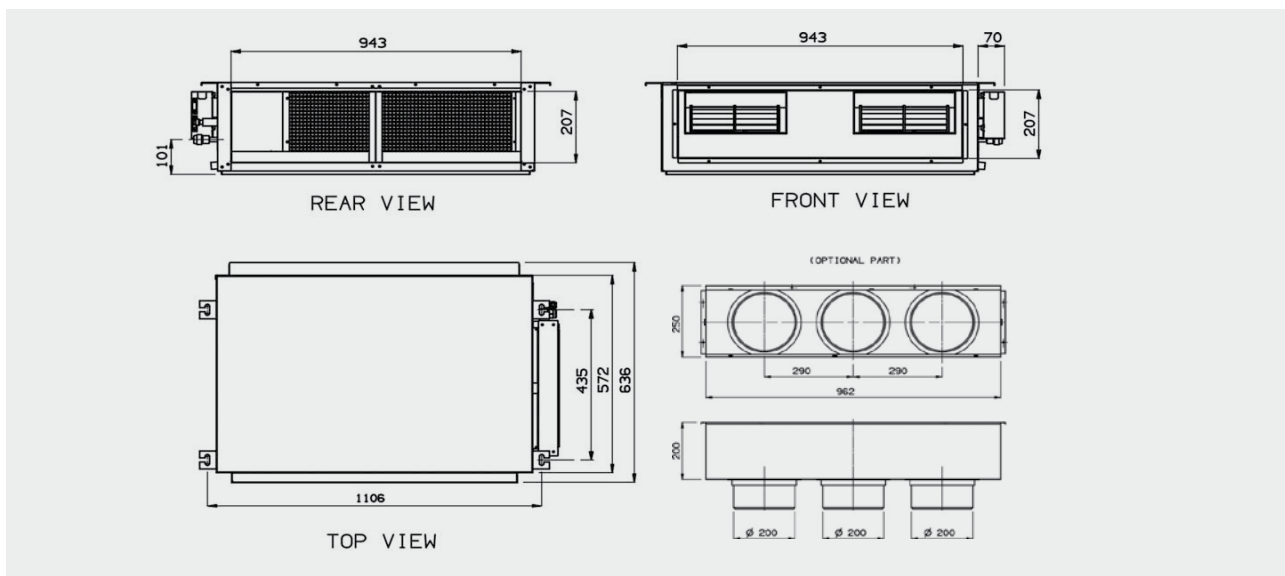

TECHNICAL DATA

PRODUCT NAME		AD45MHG	
Features	Units	Cooling	Heating
	kW	4,70	5,20
Cooling/Heating capacity	BTU/h	16.020	17.740
	kcal/h	4.040	4.470
Air flowrate Indoor (h.m.l.)	m ³ /h	875-600-400	
Dehumidification	l/h	2,3	
External static pressure (min-max)	mm W.G.	5-7	
Fan speeds	n°	3 + Auto	
Sound power Indoor (h.m.l.)	dB(A)	54-47-42	
Sound pressure Indoor (h.m.l.) at discharge plenum connection	dB(A)	45-38-33	
Sound pressure Indoor at ducts exit	dB(A)	< 20	
Power supply	V/Ph/Hz	230/1/50	
Running consumption	kW	0,138	0,138
Refrigerant type		R410A	
Liquid pipe diameter	mm(inch")	6,35(1/4")	
Gas pipe diameter	mm(inch")	12,7(1/2")	
Duct diameter of the 3-way discharge plenum (optional)	mm	200	
Net weight Indoor	kg	35	
Net dimension Indoor (H./W./D.)	mm	266x1.132x571	
Net dimension Indoor with plenum (H./W./D.)	mm	266x1.132x771	

PRODUCT NAME		ADS56MH	
Features	Units	Cooling	Heating
	kW	5,60	6,30
Cooling/Heating capacity	BTU/h	19.100	21.480
	kcal/h	4.820	5.420
Air flowrate Indoor (h.-m.-l.)	m ³ /h	875-600-400	
Dehumidification	l/h	2,3	
External static pressure (min-max)	mm W.G.	5-7	
Fan speeds	n°	3 + Auto	
Sound power Indoor (h.-m.-l.)	dB(A)	54-47-42	
Sound pressure Indoor (h.-m.-l.) at plenum connection	dB(A)	45-38-33	
Sound pressure Indoor at ducts exit	dB(A)	< 20	
Power supply	V/Ph/Hz	230/1/50	
Running consumption	kW	0,138	0,138
Refrigerant type		R410A	
Liquid pipe diameter	mm(inch")	6,35(1/4")	
Gas pipe diameter	mm(inch")	12,7(1/2")	
Duct diameter of the 3-way discharge plenum (optional)	mm	200	
Net weight Indoor	kg	35	
Net dimension Indoor (H./W./D.)	mm	266x1.132x571	
Net dimension Indoor with plenum (H./W./D.)	mm	266x1.132x771	

PRODUCT NAME		AD64MHG	
Features	Units	Cooling	Heating
	kW	6,40	7,00
Cooling/Heating capacity	BTU/h	21.850	23.870
	kcal/h	5.500	6.020
Air flowrate Indoor (h.-m.-l.)	m ³ /h	1000-700-600	
Dehumidification	l/h	2,6	
External static pressure (min-max)	mm W.G.	5-7	
Fan speeds	n°	3 + Auto	
Sound power Indoor (h.m.l.)	dB(A)	57-49-46	
Sound pressure Indoor (h.-m.-l.) at plenum connection	dB(A)	48-40-37	
Sound pressure Indoor at ducts exit	dB(A)	< 20	
Power supply	V/Ph/Hz	230/1/50	
Running consumption	kW	0,136	0,136
Refrigerant type		R410A	
Liquid pipe diameter	mm(inch")	9,52(3/8")	
Gas pipe diameter	mm(inch")	15,88(5/8")	
Duct diameter of the 3-way discharge plenum (optional)	mm	200	
Net weight Indoor	kg	35	
Net dimension Indoor (H./W./D.)	mm	266x1.132x571	
Net dimension Indoor with plenum (H./W./D.)	mm	266x1.132x771	

ADS 106-140



ADS 73

ADS 73-106-140

- Three/Four way Ducted indoor unit to be matched with Mini Multiset and Multiset V.R.F. DC Inverter systems
- Automatic change-over between cooling and heating modes
- Special function during heat pump start-up and defrosting cycle to avoid cool air emission in the room
- Night set back capability
- To be managed by the wired and wireless controllers of the Multiset V.R.F. DC Inverter systems (all optional)
- “I Feel” feature and temperature sensor inside the remote control
- Dry function
- Three-speed centrifugal fan by remote control and feature to increase speed/pressure (from 5 to 10 mm W.C.)
- Integrated pump for condensate discharge
- Dynamic refrigerant control by DC Inverter compressor and circuit, electronic valve and fuzzy logic managed by a powerful microprocessor

	A (mm)	B (mm)	C (mm)	X (mm)	Y (mm)	Weight (kg)
ADS 73	1 150	310	665	1 950	1 315	32
ADS 106/140	1 480	310	665	2 380	1 315	47

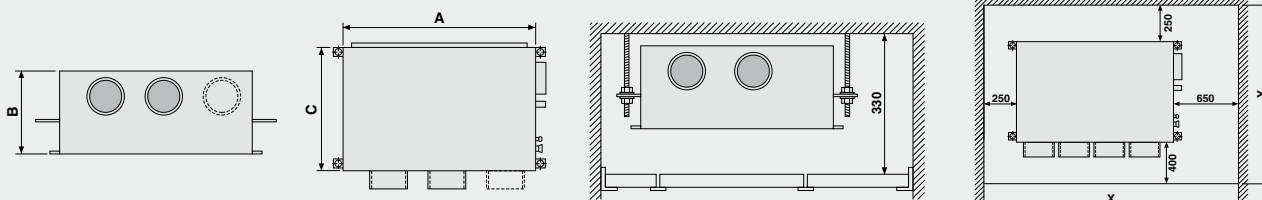

TECHNICAL DATA

PRODUCT NAME		ADS73MH	
Features	Units	Cooling	Heating
Cooling/Heating capacity	kW	7,3	8,0
	BTU/h	24.890	27.280
	kcal/h	6.280	6.880
Air flowrate Indoor (h.m.l.)	m ³ /h	1.080-900-780	
Dehumidification	l/h	3,5	
External static pressure (min-max)	mm W.G.	5,1-9,4	
Fan speeds	n°	3 + Auto	
Sound power Indoor (h.m.l.)	dB(A)	43-39-36	
Sound pressure Indoor (h.m.l.)	dB(A)	34-30-27	
Sound pressure Indoor at ducts exit	dB(A)	< 20	
Power supply	V/Ph/Hz	230/1/50	
Running consumption	kW	0,195	0,183
Refrigerant type		R410A	
Liquid pipe diameter	mm(inch")	9,52(3/8")	
Gas pipe diameter	mm(inch")	15,88(5/8")	
Ducts diameter	mm	200	
Net weight Indoor	kg	32	
Net dimension Indoor (H./W./D.)	mm	310x1.000x630	

PRODUCT NAME		ADS106MH	
Features	Units	Cooling	Heating
Cooling/Heating capacity	kW	10,6	11,4
	BTU/h	36.140	38.880
	kcal/h	9.120	9.800
Air flowrate Indoor (h.m.l.)	m ³ /h	1.800-1.560-1.260	
Dehumidification	l/h	4,2	
External static pressure (min-max)	mm W.G.	8,1-12,4	
Fan speeds	n°	3 + Auto	
Sound power Indoor (h.m.l.)	dB(A)	47-42-40	
Sound pressure Indoor (h.m.l.)	dB(A)	38-33-31	
Sound pressure Indoor at ducts exit	dB(A)	< 20	
Power supply	V/Ph/Hz	230/1/50	
Running consumption	kW	0,327	0,315
Refrigerant type		R410A	
Liquid pipe diameter	mm(inch")	9,52(3/8")	
Gas pipe diameter	mm(inch")	15,88(5/8")	
Ducts diameter	mm	200	
Net weight Indoor	Kg	47	
Net dimension Indoor (H./W./D.)	mm	310x1.480x630	

PRODUCT NAME		ADS140MH	
Features	Units	Cooling	Heating
Cooling/Heating capacity	kW	14,00	16,00
	BTU/h	47.740	54.560
	kcal/h	12.040	13.760
Air flowrate Indoor (h.m.l.)	m ³ /h	1.980-1.560-1.320	
Dehumidification	l/h	6,6	
External static pressure (min-max)	mm W.G.	8-11,5	
Fan speeds	n°	3 + Auto	
Sound power Indoor (h.m.l.)	dB(A)	49-46-42	
Sound pressure Indoor (h.m.l.)	dB(A)	40-37-33	
Sound pressure Indoor at ducts exit	dB(A)	< 20	
Power supply	V/Ph/Hz	230/1/50	
Running consumption	kW	0,325	0,313
Refrigerant type		R410A	
Liquid pipe diameter	mm(inch")	9,52(3/8")	
Gas pipe diameter	mm(inch")	15,88(5/8")	
Ducts diameter	mm	200	
Net weight Indoor	Kg	47	
Net dimension Indoor (H./W./D.)	mm	310x1.480x630	



ACS 73-106-140

- Underceiling indoor unit for Mini Multiset and Multiset V.R.F. DC Inverter systems
- Automatic change-over between cooling and heating modes
- Special function during heat pump start-up and defrosting cycle to avoid cool air emission in the room
- Night set back capability
- To be managed by the wired and wireless controllers of the Multiset V.R.F. DC Inverter systems (all optional)
- "I Feel" feature and temperature sensor inside the remote control
- Dry function
- New three-speed centrifugal fan by remote control, granting a better and low noise air diffusion
- Horizontal flap swinging or to be set on a fixed position by remote control
- Vertical flap by manual control
- Dynamic refrigerant control by DC Inverter compressor and circuit, electronic valve and fuzzy logic managed by a powerful microprocessor

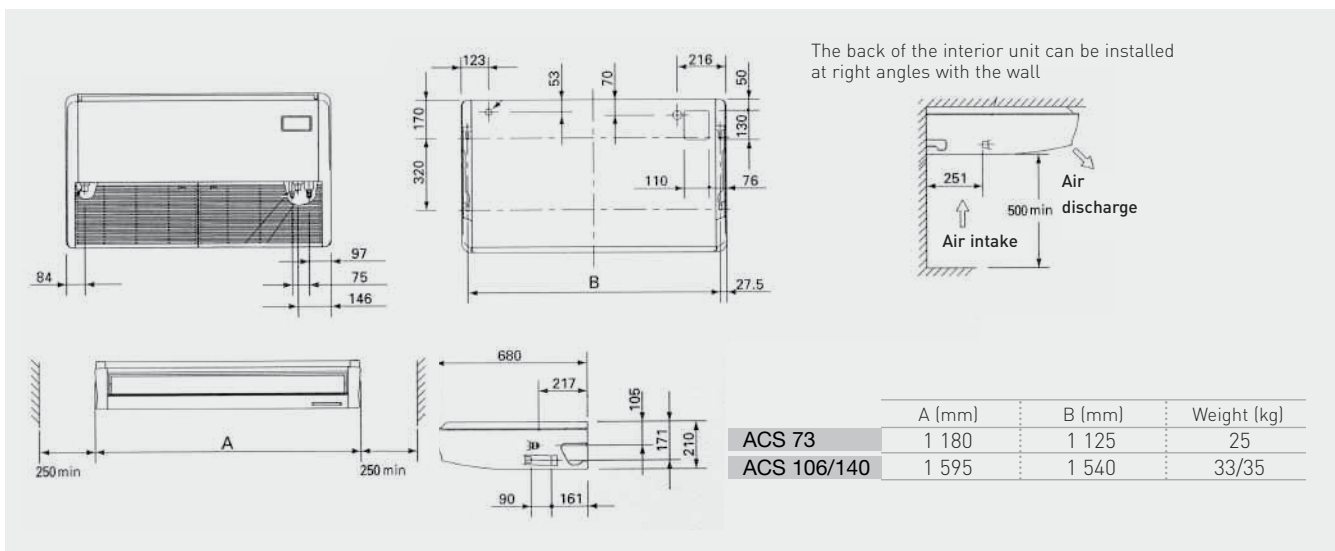

TECHNICAL DATA

PRODUCT NAME		ACS73MH	
Features	Units	Cooling	Heating
	kW	7,3	8,0
Cooling/Heating capacity	BTU/h	24.890	27.280
	kcal/h	6.280	6.880
Air flowrate Indoor (h.m.l.)	m ³ /h	1.098-900-840	
Dehumidification	l/h	3,0	
Fan speeds	n°	3 + Auto	
Sound pressure Indoor (h.m.l.)	dB(A)	38-36-33	
Sound power Indoor (h.m.l.)	dB(A)	49-47-44	
Power supply	V/Ph/Hz	230/1/50	
Running consumption	kW	0,043	0,042
Refrigerant type		R410A	
Liquid pipe diameter	mm(inch")	9,52(3/8")	
Gas pipe diameter	mm(inch")	15,88(5/8")	
Net weight Indoor	Kg	25,0	
Net dimension Indoor (H./W./D.)	mm	210x1.180x680	

PRODUCT NAME		ACS106MH	
Features	Units	Cooling	Heating
	kW	10,6	11,4
Cooling/Heating capacity	BTU/h	36.140	38.880
	kcal/h	9.120	9.800
Air flowrate Indoor (h.m.l.)	m ³ /h	1.650-1.380-1.200	
Dehumidification	l/h	3,9	
Fan speeds	n°	3 + Auto	
Sound pressure Indoor (h.m.l.)	dB(A)	41-38-35	
Sound power Indoor (h.m.l.)	dB(A)	52-49-46	
Power supply	V/Ph/Hz	230/1/50	
Running consumption	kW	0,074	0,073
Refrigerant type		R410A	
Liquid pipe diameter	mm(inch")	9,52(3/8")	
Gas pipe diameter	mm(inch")	15,88(5/8")	
Net weight Indoor	Kg	33	
Net dimension Indoor (H./W./D.)	mm	210x1.595x680	

PRODUCT NAME		ACS140MH	
Features	Units	Cooling	Heating
	kW	14,00	16,00
Cooling/Heating capacity	BTU/h	47.740	54.560
	kcal/h	12.040	13.760
Air flowrate Indoor (h.m.l.)	m ³ /h	1.800-1.560-1.320	
Dehumidification	l/h	5,6	
Fan speeds	n°	3 + Auto	
Sound pressure Indoor (h.m.l.)	dB(A)	43-40-37	
Sound power Indoor (h.m.l.)	dB(A)	54-51-48	
Power supply	V/Ph/Hz	230/1/50	
Running consumption	kW	0,086	0,085
Refrigerant type		R410A	
Liquid pipe diameter	mm(inch")	9,52(3/8")	
Gas pipe diameter	mm(inch")	15,88(5/8")	
Net weight Indoor	Kg	33,0	
Net dimension Indoor (H./W./D.)	mm	210x1.595x680	



FC 22-28-36-45-56-64

- Floor/ceiling indoor unit for Mini Multiset and Multiset V.R.F. DC Inverter systems
- Automatic change-over between cooling and heating modes
- Special function during heat pump start-up and defrosting cycle to avoid cool air emission in the room
- Night set back capability
- To be managed by the wired and wireless controllers of the Multiset V.R.F. DC Inverter systems (all optional)
- "I Feel" feature and temperature sensor inside the remote control
- Dry function
- New three-speed centrifugal fan by remote control, granting a better and low noise air diffusion
- Horizontal flap swinging or to be set on a fixed position by remote control
- Vertical flap by manual control
- Washable air filter
- Optional active carbon filters
- Dynamic refrigerant control by DC Inverter compressor and circuit, electronic valve and fuzzy logic managed by a powerful microprocessor

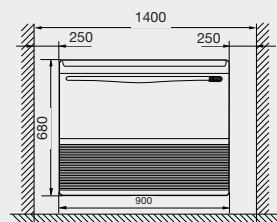
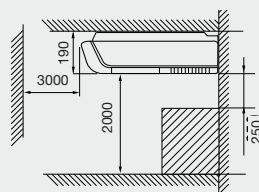
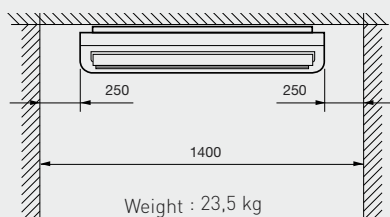

dimensions in mm

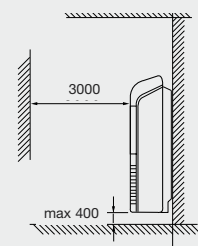

TECHNICAL DATA

PRODUCT NAME		FC22MHG		FC28MHG	
Features	Units	Cooling	Heating	Cooling	Heating
Cooling/Heating capacity	kW	2,20	2,50	2,80	3,20
	BTU/h	7.500	8.520	9.550	10.920
	kcal/h	1.890	2.150	2.410	2.750
Air flowrate Indoor (h.m.l.)	m ³ /h	700-590-500		700-590-500	
Dehumidification	l/h	1,0		1,2	
Fan speeds	n°	3 + Auto		3 + Auto	
Sound pressure Indoor (h.-m.-l.) at 2m	dB(A)	47-43-38		47-43-38	
Sound power Indoor (h.-m.-l.)	dB(A)	55-51-46		55-51-46	
Power supply	V/Ph/Hz	230/1/50		230/1/50	
Running consumption	kW	0,065	0,065	0,065	0,065
Refrigerant type		R410A		R410A	
Liquid pipe diameter	mm(inch")	6,35(1/4")		6,35(1/4")	
Gas pipe diameter	mm(inch")	12,70(1/2")		12,70(1/2")	
Net weight Indoor	Kg	23,5		23,5	
Net dimension Indoor (H./W./D.)	mm	680x900x190		680x900x190	

PRODUCT NAME		FC36MHG		FC45MHG	
Features	Units	Cooling	Heating	Cooling	Heating
Cooling/Heating capacity	kW	3,60	4,20	4,70	5,20
	BTU/h	12.280	14.320	16.020	17.740
	kcal/h	3.100	3.610	4.040	4.470
Air flowrate Indoor (h.m.l.)	m ³ /h	700-590-500		830-760-665	
Dehumidification	l/h	1,3		2,3	
Fan speeds	n°	3 + Auto		3 + Auto	
Sound pressure Indoor (h.-m.-l.) at 2m	dB(A)	47-43-38		52-49-46	
Sound power Indoor (h.-m.-l.)	dB(A)	55-51-46		60-57-54	
Power supply	V/Ph/Hz	230/1/50		230/1/50	
Running consumption	kW	0,065	0,065	0,088	0,088
Refrigerant type		R410A		R410A	
Liquid pipe diameter	mm(inch")	6,35(1/4")		6,35(1/4")	
Gas pipe diameter	mm(inch")	12,70(1/2")		12,70(1/2")	
Net weight Indoor	Kg	23,5		23,5	
Net dimension Indoor (H./W./D.)	mm	680x900x190		680x900x190	

PRODUCT NAME		FC56MHG		FC64MHG	
Features	Units	Cooling	Heating	Cooling	Heating
Cooling/Heating capacity	kW	5,60	6,30	6,40	7,00
	BTU/h	19.100	21.480	21.850	23.870
	kcal/h	4.820	5.420	5.500	6.020
Air flowrate Indoor (h.m.l.)	m ³ /h	830-760-665		830-760-665	
Dehumidification	l/h	2,3		2,3	
Fan speeds	n°	3 + Auto		3 + Auto	
Sound pressure Indoor (h.-m.-l.) at 2m	dB(A)	52-49-46		52-49-46	
Sound power Indoor (h.-m.-l.)	dB(A)	60-57-54		60-57-54	
Power supply	V/Ph/Hz	230/1/50		230/1/50	
Running consumption	kW	0,088	0,088	0,088	0,088
Refrigerant type		R410A		R410A	
Liquid pipe diameter	mm(inch")	6,35(1/4")		9,52(3/8")	
Gas pipe diameter	mm(inch")	12,70(1/2")		15,88(5/8")	
Net weight Indoor	Kg	23,5		23,5	
Net dimension Indoor (H./W./D.)	mm	680x900x190		680x900x190	



SD 22-28-36-45-56-64

- Slim ducted indoor unit, available for floor or wall or ceiling installation, to be matched with Mini Multiset and Multiset V.R.F. DC Inverter systems
- Especially projected for hotel applications
- Automatic change-over between cooling and heating modes
- Special function during heat pump start-up and defrosting cycle to avoid cool air emission in the room
- Night set back capability
- To be managed by the wired and wireless controllers of the Multiset V.R.F. DC Inverter systems (all optional)
- "I Feel" feature and temperature sensor inside the remote control
- Dry function
- New three-speed centrifugal fan by remote control, granting a better and low noise air diffusion
- Washable air filter
- Optional active carbon filters
- Dynamic refrigerant control by DC Inverter compressor and circuit, electronic valve and fuzzy logic managed by a powerful microprocessor

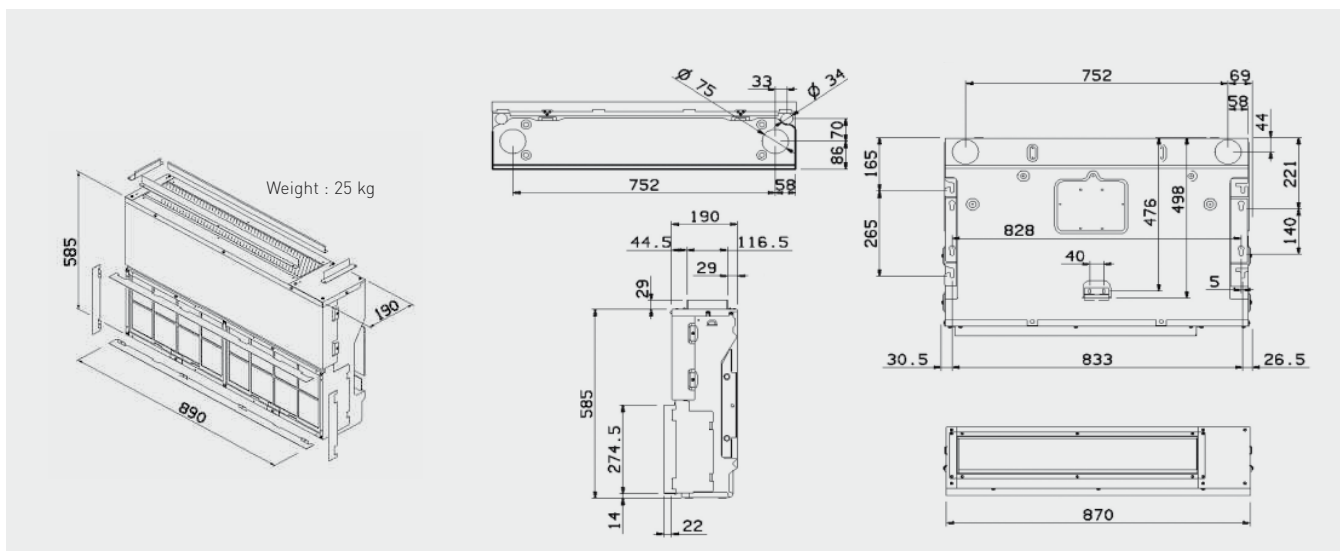

TECHNICAL DATA

PRODUCT NAME		SD22MHG		SD28MHG	
Features	Units	Cooling	Heating	Cooling	Heating
Cooling/Heating capacity	kW	2,20	2,50	2,80	3,20
	BTU/h	7.500	8.520	9.550	10.920
	kcal/h	1.890	2.150	2.410	2.750
Air flowrate Indoor (h.m.l.)	m ³ /h	470-380-340		470-380-340	
Dehumidification	l/h	1,0		1,2	
Fan speeds	n°	3 + Auto		3 + Auto	
Sound pressure Indoor (h.-m.-l.) at 2m	dB(A)	37-30-26		37-30-26	
Sound power Indoor (h.-m.-l.)	dB(A)	45-38-34		45-38-34	
Power supply	V/Ph/Hz	230/1/50		230/1/50	
Running consumption	kW	0,037	0,037	0,037	0,037
Refrigerant type		R410A		R410A	
Liquid pipe diameter	mm(inch")	6,35(1/4")		6,35(1/4")	
Gas pipe diameter	mm(inch")	12,70(1/2")		12,70(1/2")	
Net weight Indoor	Kg	25		25	
Net dimension Indoor (H./W./D.)	mm	585x890x190		585x890x190	

PRODUCT NAME		SD36MHG		SD45MHG	
Features	Units	Cooling	Heating	Cooling	Heating
Cooling/Heating capacity	kW	3,60	4,20	4,70	5,20
	BTU/h	12.280	14.320	16.020	17.740
	kcal/h	3.100	3.610	4.040	4.470
Air flowrate Indoor (h.m.l.)	m ³ /h	470-380-340		620-540-450	
Dehumidification	l/h	1,3		2,3	
Fan speeds	n°	3 + Auto		3 + Auto	
Sound pressure Indoor (h.-m.-l.) at 2m	dB(A)	37-30-26		45-41-33	
Sound power Indoor (h.-m.-l.)	dB(A)	45-38-34		53-49-41	
Power supply	V/Ph/Hz	230/1/50		230/1/50	
Running consumption	kW	0,037	0,037	0,065	0,065
Refrigerant type		R410A		R410A	
Liquid pipe diameter	mm(inch")	6,35(1/4")		6,35(1/4")	
Gas pipe diameter	mm(inch")	12,70(1/2")		12,70(1/2")	
Net weight Indoor	Kg	25		25	
Net dimension Indoor (H./W./D.)	mm	585x890x190		585x890x190	

PRODUCT NAME		SD56MHG		SD64MHG	
Features	Units	Cooling	Heating	Cooling	Heating
Cooling/Heating capacity	kW	5,60	6,30	6,40	7,00
	BTU/h	19.100	21.480	21.850	23.870
	kcal/h	4.820	5.420	5.500	6.020
Air flowrate Indoor (h.m.l.)	m ³ /h	620-540-450		680-600-520	
Dehumidification	l/h	2,3		3,3	
Fan speeds	n°	3 + Auto		3 + Auto	
Sound pressure Indoor (h.-m.-l.) at 2m	dB(A)	45-41-33		49-45-40	
Sound power Indoor (h.-m.-l.)	dB(A)	53-49-41		57-53-48	
Power supply	V/Ph/Hz	230/1/50		230/1/50	
Running consumption	kW	0,065	0,065	0,088	0,088
Refrigerant type		R410A		R410A	
Liquid pipe diameter	mm(inch")	6,35(1/4")		9,52(3/8")	
Gas pipe diameter	mm(inch")	12,70(1/2")		15,88(5/8")	
Net weight Indoor	Kg	25		25	
Net dimension Indoor (H./W./D.)	mm	585x890x190		585x890x190	













TECHNICAL DATA

PRODUCT NAME		ADPS140MH	
Features	Units	Cooling	Heating
Cooling/Heating capacity	kW	14,0	16,0
Air flowrate (h.m.l.)	m ³ /h	2160/2100/1980	
External static pressure (max)	Pa	167	
Fan speeds	n°	3 + Auto	
Sound power (h.m.l.)	dB(A)	47/46/44	
Sound pressure (h.m.l.)	dB(A)	58/57/55	
Power supply	V/Ph/Hz	230/1/50	
Running consumption (min.-med.-max.)	kW	0,60/0,66/0,71	0,60/0,66/0,71
Running current (min.-med.-max.)	A	2,80/2,90/3,00	2,80/2,90/3,00
Liquid pipe diameter	mm(inch")	9,52(3/8")	
Gas pipe diameter	mm(inch")	15,88(5/8")	
Net weight	Kg	54	
Net dimensions (H./W./D.)	mm	450/1065/620	







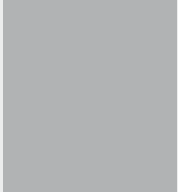











































PRODUCT NAME		ADPS224MH	
Features	Units	Cooling	Heating
Cooling/Heating capacity	kW	22,4	25
Air flowrate (h.m.l.)	m ³ /h	3360/3190/2980	
External static pressure (max)	Pa	176	
Fan speeds	n°	3 + Auto	
Sound power (h.m.l.)	dB(A)	48/47/46	
Sound pressure (h.m.l.)	dB(A)	59/58/57	
Power supply	V/Ph/Hz	230/1/50	
Running consumption (min.-med.-max.)	kW	0,87/0,90/0,93	0,87/0,90/0,93
Running current (min.-med.-max.)	A	4,50/4,06/4,07	4,05/4,06/4,07
Liquid pipe diameter	mm(inch")	9,52(3/8")	
Gas pipe diameter	mm(inch")	19,05(3/4")	
Net weight	Kg	110	
Net dimensions (H./W./D.)	mm	467/1428/1230	

PRODUCT NAME		ADPS280MH	
Features	Units	Cooling	Heating
Cooling/Heating capacity	kW	28,0	31,50
Air flowrate (h.m.l.)	m ³ /h	4320/4200/3960	
External static pressure (max)	Pa	216	
Fan speeds	n°	3 + Auto	
Sound power (h.m.l.)	dB(A)	51/50/49	
Sound pressure (h.m.l.)	dB(A)	62/61/60	
Power supply	V/Ph/Hz	230/1/50	
Running consumption (min.-med.-max.)	kW	1,27/1,33/1,39	1,27/1,33/1,39
Running current (min.-med.-max.)	A	6,04/6,06/6,07	6,04/6,06/6,07
Liquid pipe diameter	mm(inch")	9,52(3/8")	
Gas pipe diameter	mm(inch")	22,22 (7/8")	
Net weight	Kg	120	
Net dimensions (H./W./D.)	mm	467/1428/1230	













































CONTROLS AND ACCESSORIES

<p>Infrared remote controller to be used with high-wall indoor units</p>		<p>Schedule timer able to manage up to 64 indoor units with customized programming of all features, on/off cycles, etc.</p>	
<p>Infrared remote controller to be used with cassette and floor/ceiling indoor units</p>		<p>System controller to be used to manage only on/off cycles for a system up to 16 groups / 64 indoor units, to be used in matching with other controllers (remote controllers, system controllers, etc.)</p>	
<p>Infrared remote controller to be used with underceiling indoor units</p>		<p>System controller to be used to manage and program a system up to 16 groups / 64 indoor units, with or without remote controllers; it can be matched with schedule timer and intelligent controller</p>	
<p>Infrared remote controller to be used, in matching with a special infrared receiver, with the full range of indoor units; it shows the operation status of the air-conditioner</p>		<p>Interface PLC for outdoor units: can control up to 4 outdoor units. Required for "Demand" control, typical of 3-way systems</p>	
<p>Standard wired remote controller with full features control, self-diagnostic and centralized programming capabilities</p>		<p>New standard wired remote controller equipped with weekly timer, characterized by full features control, selfdiagnostic and centralized programming capabilities.</p>	
<p>Simplified wired remote controller to be used with the full range of indoor units; it controls all the main features</p>		<p>New Touch Screen Intelligent Controller for WEB: to be used to manage and program a system up to 256 indoor units, organized in 4 groups of 64 units each, also without wired controllers; it can be matched with the schedule timer and in case of three/four-group installations it must be connected with the communication adapter on the outdoor unit.</p>	
<p>Remote sensor to be used with the full range of indoor units to detect the room temperature when no remote controller sensor or body sensor is used: suggested for air-conditioner systems without remote controller</p>		<p>User friendly touch screen operation. Web browser: it allows to control VRF system by its own PC at home using an Internet connection with a LAN cable.</p>	

MULTISET V.R.F. CONTROLS FUNCTIONS

	INDIVIDUALS CONTROLS				TIMER
Picture					
Description	Standard wired Control	Standard wired Control + Timer	Simplified wired Control	Infrared remote Control	Weekly Timer
Model	REM HW standard	REM HW TM	REM HWS	REM HL	REM HW T
Functions					-
	 17 / 27 °C	 17 / 27 °C	 17 / 27 °C	 17 / 27 °C	-
	 16 / 26 °C	 16 / 26 °C	 16 / 26 °C	 16 / 26 °C	-
	 18 / 30 °C	 18 / 30 °C	 18 / 30 °C	 18 / 30 °C	-
	 18 / 30 °C	 18 / 30 °C	 18 / 30 °C	 18 / 30 °C	-
	 3 + auto	 3 + auto	 3 + auto	 3 + auto	-
	 temperature +/-	 temperature +/-	 temperature +/-	 temperature +/-	-
	 flap	 flap	 flap	 flap	-
	 timer 72	 weekly timer	-	 timer 72 h	 weekly timer
	 sensor t.(2)	 sensor t.(2)	 sensor t.(2)	 sensor t.(2)	Interdiction to use indoor unit control functions
	 Fault alarm	 Fault alarm	 Fault alarm	-	-
	 Dirty filter	 Dirty filter	 Dirty filter	-	-
N° of units controlled	max. 8	max. 8	max. 8	max. 8	1 group with 64 units 8 groups with 8 units 4 groups with 16 units
Other	It works only with a secondary control	It works only with a secondary control	It works only with a secondary control	It works only with a secondary control	6 daily programs x 7 days + holiday
				You can select 6 different addresses	Power supply by REM HW-64 S or T10-PCB indoor unit connector

MULTISET V.R.F. CONTROLS FUNCTIONS

GROUP CONTROLS						
Picture						
Description	System control	ON/OFF System control	Intelligent touch controller	Adapter for control system	LonWorks Interface	PLC Interface
Model	REM HW 64S	REM HW 16S	REM HW 256S	REM HWAS	LWI	IEM
Functions				-		
	 17 / 27 °C	-	 17 / 27 °C	-	 17 / 27 °C	 17 / 27 °C
	 16 / 26 °C	-	 16 / 26 °C	-	 16 / 26 °C	 16 / 26 °C
	 18 / 30 °C	-	 18 / 30 °C	-	 18 / 30 °C	 18 / 30 °C
	 18 / 30 °C	-	 18 / 30 °C	-	 18 / 30 °C	 18 / 30 °C
	 3 + auto	-	 3 + auto	-	 3 + auto	 3 + auto
	 temperature +/-	-	 temperature +/-	-	 temperature +/-	 temperature +/-
	 flap	-	 flap	-	 flap	 flap
	-	-	 timer	-	-	-
	Interdiction to use indoor unit control functions	-	Interdiction to use indoor unit control functions	-	-	-
	 Malfunctions report	-	 Fault alarm	-	 Fault alarm	-
	 Dirty filter	-	-	-	-	-
	N° of units controlled	16 groups of 4 units (max 64 units)	16 groups of 4 units (max 64 units)	64 units x 4 systems max 256 indoor units 30 units x 4 systems max 120 outdoor units	2 systems, 64 units x 2 max 128 units	16 groups of 4 units (max 64 units)
Other			Over 3 systems you must use REMHWAS (max 7)	to use with REMHWAS (+3 systems)	The control central can perform functions of remote control and system control, Intelligent Controller	You must use the individual controls
			Monitoring and calculation of consumption distribution			



RCT 55/75/100

- The total heat exchangers RCT series are characterized by high airflow, granting right conditions of temperature and humidity in commercial areas of medium size
- They integrate the total heat recovery technology with the direct expansion, for an optimal temperature control
- Compact and silent
- High recovery efficiency on both temperature and humidity
- High static pressure available
- The plenum with circular attacks ensures a quick and easy access to ducts
- Washable filters help to prevent mould and bacteria
- Easy to install and maintain thanks to the external electric panel
- To be matched with MINI&2/3-way MULTiset outdoor units
- 3-Way: Solenoid valve kit is required for each unit
- 2-Way: RAP kit is required for each unit

MODELS			RCT 50	RCT 75	RCT 100
Air circulation	H	m ³ /h	500	750	1000
Power supply		V/ph/Hz	230/1/50		
Fresh air load treatment capacity ⁽¹⁾	cooling	kW	5,3 [1,7] ¹	8,2 [2,6] ¹	10,7 [3,4] ¹
	heating	kW	6,5 [2,3] ¹	9,8 [3,5] ¹	12,6 [4,6] ¹
Enthalpy Exchange Efficiency	cooling	%	59		
	heating	%	67		
Temp exchange efficiency				75	
Equivalent cooling capacity		kW	3,6	5,6	7,3
		BTU/h	12000	19000	25000
Power input	cooling	kW	0,532	0,737	0,798
	heating	kW	0,532	0,737	0,798
Running ampères	cooling	A	2,4	3,2	3,5
	heating	A	2,4	3,2	3,5
FAN MOTOR					
Type			sirocco		
External static pressure-return air		Pa	183	221	135
External static pressure-supply air		Pa	205	264	176
Output		kW	0,28(4P)x2	0,35(4P)x2	
Power sound level	cooling	dB [A]	57	58	59
	heating	dB [A]	58	59	60
Pressure sound level	cooling	dB [A]	46	47	48
	heating	dB [A]	47	48	49
Piping connections - Liquid (flare)		mm(inch")	6,35(1/4")		
Piping connections - Gas (flare)		mm(inch")	12,7(1/2")		
Piping connections - Drain piping			VP-25		
Connection duct diameter		mm	250		300
DIMENSIONS/WEIGHT					
Height/Width/Depth		mm	425/1785/1000	425/1903/1120	425/1903/1220
Net weight		Kg	134	153	168

⁽¹⁾ Heat recovery capacity by heat exchanger



REC 03/06/10/14/19/25/30/40

- REC heat recovery units, characterized by small size and easy to install, are suitable for residential and commercial applications
- Regulations require forced ventilation in realizing air conditioning and air treatment systems, with expulsion of air treated and consequent increase in energy consumption and costs.
- In all these cases REC heat recovery units allow over 50% of energy saving and ensure an adequate environmental comfort through the use of a static heat exchanger made of aluminium.
- REC heat recovery units are available in 8 sizes with airflows from 300 to 4000 m³ /h and high static pressure.
- They work both in the summer and in winter.
- Particularly suitable for false ceiling installation, they may be appropriately ducted allowing air supply and air suction directly in the room.
- High efficiency aluminium plated heat recovery, with airflows separated by special seals.
- The side panels are fully removable, made of double-layer plate with thermal and sound insulation in polyethylene / polyester with an average thickness of 10 mm for models REC 03-06-10 and 20mm for the other models.
- In the lower part of the recovery unit is installed a condensate tank in stainless steel, with drain downward.
- The fan group consists of 2 centrifugal fans with double inlet (for the REC 03 model single inlet) separated, one for the recovery fresh air, the other for the exhaust air.
- Single-phase electric motors (3-phase only for REC 40), 2 or 3 speeds.
- The fans are mounted on anti-vibration easy removable support, which ensures a very low noise even at maximum speed.
- They are also equipped with air filters with performance class G3, easily removable from each side of the unit and regenerate.
- REC heat recovery units are available also in vertical version.

MAIN ACCESSORIES



- Speed control REC./CNTL-3 S - CVU
- Remote control panel PCR
- Additional Heating resistance EH
- Internal water heating coil SKW
- High efficiency filters FTK
- Round adapter for circular duct BCC

HEAT RECOVERY UNITS

VERSIONE ORIZZONTALE
HORIZONTAL CONFIGURATION

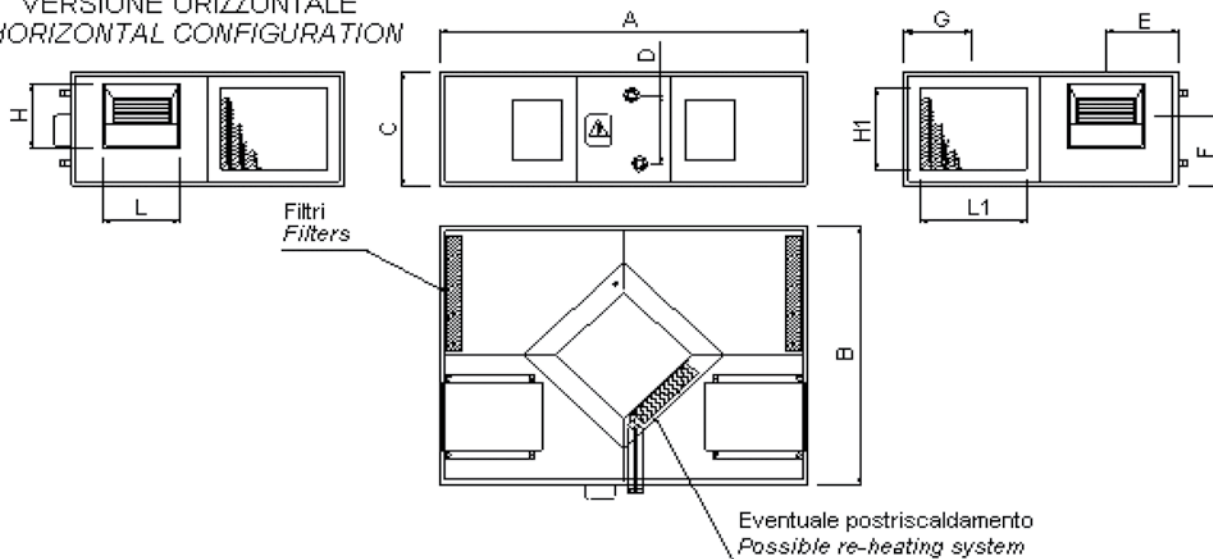

MODELLO MODEL		03	06	10	14	19	25	30	40
A	mm	990	990	1150	1350	1450	1700	1700	1700
B	mm	750	750	860	900	900	1230	1230	1230
C	mm	270	270	385	410	470	490	530	630
D	mm	-	-	230	230	280	305	305	405
L	mm	162	162	240	240	240	306	339	339
H	mm	100	100	218	270	270	270	297	297
L1	mm	275	275	330	337	337	502	502	502
H1	mm	153	153	267	267	327	347	387	487
E	mm	195	195	245	241	241	323	308	308
E1	mm	195	195	205	241	241	323	345	345
F	mm	170	170	238	224	284	290	331	377
G	mm	197	197	225	241	241	323	323	323
φ		1/2"	1/2"	1/2"	1/2"	1/2"	1/2"	1/2"	1/2"
	kg	39	41	68	91	99	140	155	179

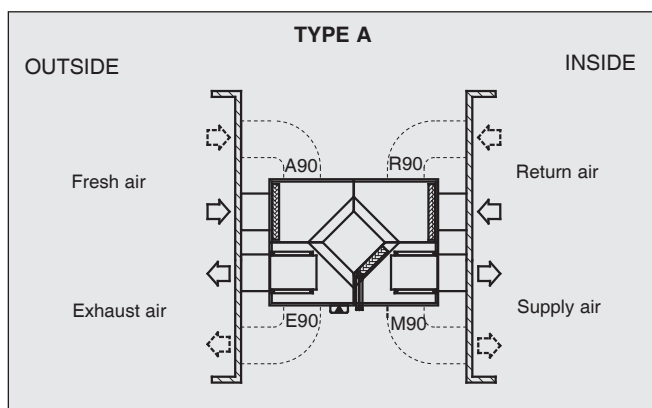

MODELS			REC 03	REC 06	REC 10	REC 14
Airflow rate	Max	m ³ /h	300	500	1000	1400
	Med		200	300	900	1250
	Min		100	150	800	850
External static pressure	Max	Pa	100	100	90	145
	Med		160	129	70	133
	Min		167	127	47	113
1 m sound pressure level	Max	dB (A)	51,1	51,1	52,2	62,3
	Med		49,7	47,4	48,8	56,9
	Min		44,3	41,0	45,3	45,6
Recovery efficiency ⁽¹⁾	Max	%	52,0	56,1	53,4	52,1
	Med		57,0	62,5	54,8	53,5
	Min		66,4	71,1	56,3	58,4
Saved power ⁽¹⁾	Max	kW	1,4	2,6	4,9	6,7
	Med		1,0	1,7	4,5	6,1
	Min		0,6	1,0	4,1	4,5
Supply temperature ⁽¹⁾	Max	°C	8,0	9,0	8,4	8,0
	Med		9,3	10,6	8,7	8,4
	Min		11,6	12,8	9,1	9,6
FAN						
Shaft power		W	2x60	2x60	2x147	2x350
Maximum current		A	1,2	1,4	3	5,8
Fan speeds		n°	3	3	3	3
Poles		n°	2	2	4	4
Protection degree - minimum		IP	20			
Temperature class - minimum			B			
Power supply		V/ph/Hz	230/1/50			
DIMENSIONS / WEIGHT - REC						
Width/Length/Height		mm	990/750/270	990/750/270	1150/860/385	1350/900/410
Net weight		Kg	39	41	68	91

⁽¹⁾ At the following conditions: room air temperature 20°C DB 50% R.H.; fresh air temperature -5°C.

MODELS			REC 19	REC 25	REC 30	REC 40
Airflow rate	Max	m ³ /h	1900	2500	3200	4000
	Med		1570	1830	2500	-
	Min		1340	1100	1800	3000
External static pressure	Max	Pa	120	110	170	170
	Med		121	112	159	-
	Min		119	112	144	147
1 m sound pressure level	Max	dB (A)	58,4	56,0	58,8	62,1
	Med		53,7	51,0	53,5	-
	Min		42,1	44,6	51,1	54,9
Recovery efficiency ⁽¹⁾	Max	%	51,8	57,6	56,0	55,7
	Med		54,1	61,5	59,0	-
	Min		56,1	67,7	63,1	59,2
Saved power ⁽¹⁾	Max	kW	9,0	13,2	16,4	20,3
	Med		7,8	10,3	13,5	-
	Min		6,9	8,6	10,4	16,2
Supply temperature ⁽¹⁾	Max	°C	7,9	9,4	9,0	8,9
	Med		8,5	10,4	9,8	-
	Min		9,0	11,9	10,8	9,8
FAN						
Shaft power		W	2x350	2x350	2x550	2x750
Maximum current		A	6,2	6	11,4	6,2
Fan speeds		n°	3	3	3	2
Poles		n°	4	4	4	4
Protection degree - minimum		IP	20			
Temperature class - minimum			B			
Power supply		V/ph/Hz	230/1/50			400/3/50
DIMENSIONS / WEIGHT - REC						
Width/Length/Height		mm	1450/900/470	1700/1230/490	1700/1230/530	1700/1230/630
Net weight		Kg	99	140	155	179

⁽¹⁾ At the following conditions: room air temperature 20°C DB 50% R.H.; fresh air temperature -5°C.

ENERGY LABEL - APPLICATION RULES

Our air conditioners are fully compliant to the most recent European regulations concerning the reduction of the energy consumption and the lessening of the atmosphere pollution.

The energy labels, indicating the energy efficiency class, have been introduced by the European Directive 2002/31/EC, which makes reference to the standard EN14511 for the determination of the energy class. The energy labels must be applied on products (air-conditioners air-to-air up to 12 kW of cooling capacity) in exposition on the points of sale, with the objective of giving information on the energy efficiency of the air-conditioners to the final user.

The energy label is divided in two parts: one is coloured and generic, the other, adhesive and black and white, contains the technical and efficiency data of each product or combination of indoor/outdoor units and must be stucked on the one, in the empty space.

Our company supplies both parts of the energy label: the one, coloured, is delivered directly to the points of sale (responsible for the application of the energy label on the products in exposition), the other (black and white) with technical and efficiency data is put directly inside the product carton box at the end of the production process (to make easier for the seller the application of the right label).

If the black & white part of the energy label is lost, each point of sale can immediately download it from the dedicated section in our Web Site, or ask for it to our Marketing Department.

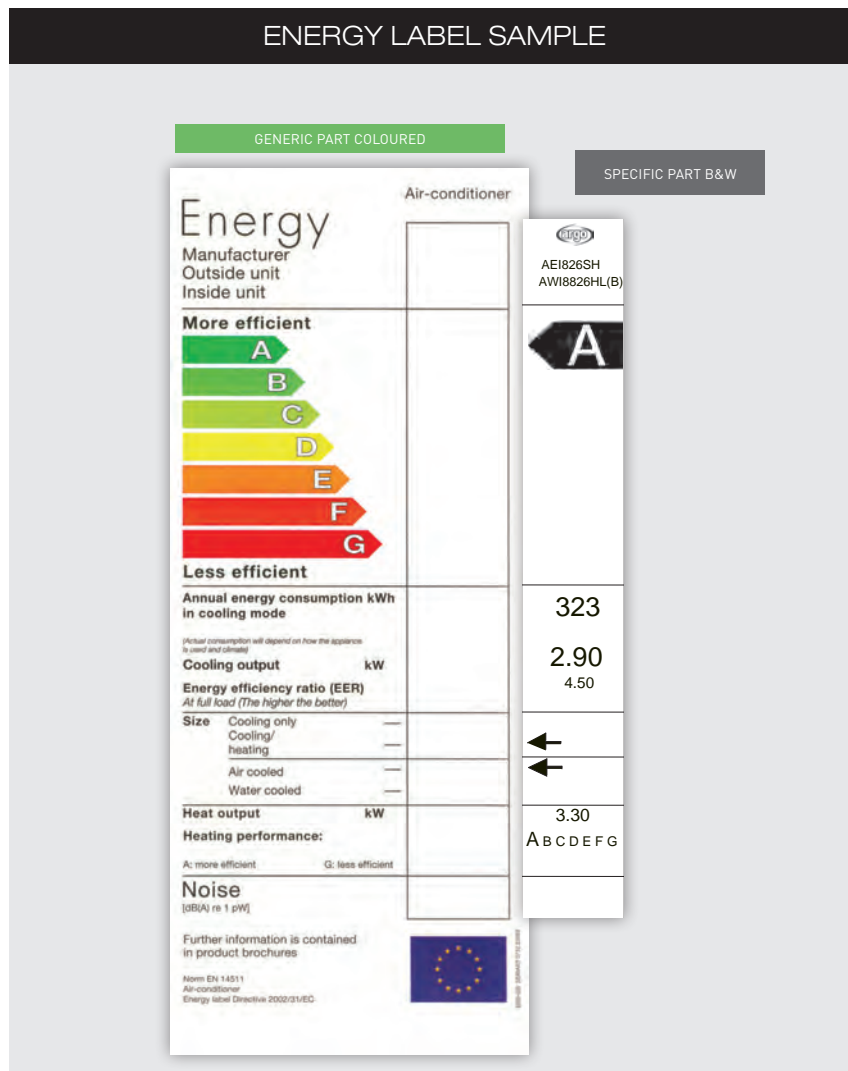

The energy label shows the belonging class: "A" class is the best one and it is assigned on the basis of specific tables that put in relation the thermal capacity and the energy consumption for each product. The ratios used to assign the energy class are the following:

E.E.R. = Energy Efficiency Ratio, is the relation between the cooling capacity (kW) and the power consumption in cooling mode (kW)

C.O.P. = Coefficient Of Performance, is the relation between the heating capacity (kW) and the power consumption in heating mode (kW)



improve your life

argoclima S.p.A.

headquarter

Via Varese, 90

21013 Gallarate (VA) ITALY

Tel: +39 0331 755111

Fax: +39 0331 776240

www.argoclima.com

 <http://gettag.mobi>

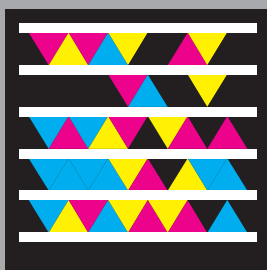

QR CODE



www.argoclima.com

The manufacturing company doesn't assume any responsibility for mistakes or omissions contained in this catalogue and reserves the right to make at any time, even without notice, any change considered suitable for technical or commercial purposes to its products.

Argo is a brand of **argoclima** S.p.A, European leader in Air Conditioning, Heating and Air Treatment.